

Dell™ PowerVault™ LTO4-120HH Tape Drive User's Guide

[Introduction](#)

[Setting Up the Tape Drive](#)

[Using the Tape Drive](#)

[Using the Tape Backup Software](#)

[Troubleshooting](#)

[Specifications](#)

[Getting Help](#)

[Contacting Dell](#)

[Appendix - Regulatory Information](#)

[Glossary](#)



NOTE: A NOTE indicates important information that helps you make better use of your system.



NOTICE: A NOTICE indicates either potential damage to hardware or loss of data and tells you how to avoid the problem.



CAUTION: A CAUTION indicates a potential for property damage, personal injury, or death.

Information in this document is subject to change without notice.

© 2007 Dell Inc. All rights reserved.

© International Business Machines Corporation, 2007. All rights reserved.

Trademarks used in this text: *Dell*, the *DELL* logo, and *PowerVault*, are trademarks of Dell Inc. *Microsoft* and *Windows* are registered trademarks of Microsoft Corporation.

Other trademarks and trade names may be used in this document to refer to either the entities claiming the marks and names or their products. Dell Inc. disclaims any proprietary interest in trademarks and trade names other than its own.

Internal Drive Model Number: LTO Ultrium4-H

External Drive Model Number: LTO4-EH1

Initial release: October 2007

Appendix - Regulatory Information: Dell™ PowerVault™ LTO4-120HH Tape Drive User's Guide

Regulatory Information for Taiwan



BSMI 通告 (僅限於台灣)

大多數的 IBM Taiwan 電腦系統被 BSMI (經濟部標準檢驗局) 劃分為乙類數位裝置。但是, 使用某些選件會使有些組態的等級變成甲類。若要確定您的電腦系統適用等級, 請檢查所有位於電腦底部或背面板、擴充卡安裝托架, 以及擴充卡上的 BSMI 註冊標籤。如果其中有一甲類標籤, 即表示您的系統為甲類數位裝置。如果只有 BSMI 的檢磁號碼標籤, 則表示您的系統為乙類數位裝置。

一旦確定了系統的 BSMI 等級, 請閱讀相關的 BSMI 通告。請注意, BSMI 通告規定凡是未經 IBM Taiwan Inc. 明確批准的擅自變更或修改, 將導致您失去此設備的使用權。

此裝置符合 BSMI (經濟部標準檢驗局) 的規定, 使用時須符合以下兩項條件:

- 此裝置不會產生有害干擾。
- 此裝置必須能夠接受所接收到的干擾, 包括可能導致無法正常作業的干擾。

甲類

此設備經測試證明符合 BSMI (經濟部標準檢驗局) 之甲類數位裝置的限制規定。這些限制的目的是為了在商業環境中使用此設備時, 能提供合理的保護以防止有害的干擾。此設備會產生、使用並散發射頻能量; 如果未遵照製造廠商的指導手冊來安裝和使用, 可能會干擾無線電通訊。請勿在住宅區使用此設備。

警告使用者:
這是甲類的資訊產品, 在居住的環境中使用時, 可能會造成射頻干擾,
在這種情況下, 使用者會被要求採取某些適當的對策。

公司連絡詳情 (僅限於臺灣)

根據商品檢驗法 (Commodity Inspection Act) 第 11 條的規定, IBM 臺灣軟體技術支援 (IBM Taiwan, Inc.) 就本文件所指的產品提供台灣地區認證機構的連絡詳情如下:

IBM 臺灣軟體技術支援
110 臺北市信義區松仁路 7 號 4 樓

本文件中的資訊如有更改, 恕不另行通知。
© 2007 年 Dell Inc. 版權所有, 翻印必究。列印於墨西哥。
未經 Dell Inc. 的書面許可, 不得以任何形式進行複製。

本文中使用的商標: Dell 和 DELL 徽標是 Dell Inc. 的商標; IBM 是 International Business Machines Corporation 的註冊商標。
本文件中述及的其他商標和產品名稱是指擁有相應商標和名稱的公司實體或其產品。Dell 對本公司之外的商標和產品名稱不擁有任何所有權。

Figure 17. Taiwan Contact Information Statement

[Back to Contents Page](#)

Contacting Dell: Dell™ PowerVault™ LTO4-120HH Tape Drive User's Guide

To contact Dell electronically, you can access the following websites:

- 1 www.dell.com
- 1 support.dell.com (support)
- 1 www.dell.com/regulatory_compliance (regulatory compliance informaton)

For specific web addresses for your country, find the appropriate country section in the table below.

☒ NOTE: Toll-free numbers are for use within the country for which they are listed.

☒ NOTE: In certain countries, support specific to Dell™ XPS™ computers is available at a separate telephone number listed for participating countries. If you do not see a telephone number listed that is specific for XPS computers, you may contact Dell through the support number listed and your call will be routed appropriately.

When you need to contact Dell, use the electronic addresses, telephone numbers, and codes provided in the following table. If you need assistance in determining which codes to use, contact a local or an international operator.

☒ NOTE: The contact information provided was deemed correct at the time that this document went to print and is subject to change.

Country (City) International Access Code Country Code City Code	Department Name or Service Area, Website and E-Mail Address	Area Codes, Local Numbers, and Toll-Free Numbers
Anguilla	General Support	toll-free: 800-335-0031
Antigua and Barbuda	General Support	1-800-805-5924
Argentina (Buenos Aires) International Access Code: 00 Country Code: 54 City Code: 11	Website: www.dell.com.ar	
	E-mail: us_latam_services@dell.com	
	E-mail for desktop and portable computers: la-techsupport@dell.com	
	E-mail for servers and EMC® storage products: la_enterprise@dell.com	
	Customer Care	toll-free: 0-800-444-0730
	Technical Support	toll-free: 0-800-444-0733
	Technical Support Services	toll-free: 0-800-444-0724
	Sales	0-810-444-3355
Aruba	General Support	toll-free: 800-1578
Australia (Sydney) International Access Code: 0011 Country Code: 61 City Code: 2	Website: support.ap.dell.com	
	E-mail: support.ap.dell.com/contactus	
	General Support	13DELL-133355
Austria (Vienna) International Access Code: 900 Country Code: 43 City Code: 1	Website: support.euro.dell.com	
	E-mail: tech_support_central_europe@dell.com	
	Home/Small Business Sales	0820 240 530 00
	Home/Small Business Fax	0820 240 530 49
	Home/Small Business Customer Care	0820 240 530 14
	Preferred Accounts/Corporate Customer Care	0820 240 530 16
	Support for XPS	0820 240 530 81
	Home/Small Business Support for all other Dell computers	0820 240 530 17
	Preferred Accounts/Corporate Support	0660 8779

	Switchboard	0820 240 530 00
Bahamas	General Support	toll-free: 1-866-278-6818
Barbados	General Support	1-800-534-3066
Belgium (Brussels) International Access Code: 00 Country Code: 32 City Code: 2	Website: support.euro.dell.com	
	Tech Support for XPS	02 481 92 96
	Tech Support for all other Dell computers	02 481 92 88
	Tech Support Fax	02 481 92 95
	Customer Care	02 713 15 65
	Corporate Sales	02 481 91 00
	Fax	02 481 92 99
	Switchboard	02 481 91 00
Bermuda	General Support	1-800-342-0671
Bolivia	General Support	toll-free: 800-10-0238
Brazil International Access Code: 00 Country Code: 55 City Code: 51	Website: www.dell.com/br	
	Customer Support, Tech Support	0800 90 3355
	Technical Support Fax	51 481 5470
	Customer Care Fax	51 481 5480
	Sales	0800 90 3390
British Virgin Islands	General Support	toll-free: 1-866-278-6820
Brunei Country Code: 673	Technical Support (Penang, Malaysia)	604 633 4966
	Customer Care (Penang, Malaysia)	604 633 4888
	Transaction Sales (Penang, Malaysia)	604 633 4955
Canada (North York, Ontario) International Access Code: 011	Online Order Status: www.dell.ca/ostatus	
	AutoTech (automated Hardware and Warranty Support)	toll-free: 1-800-247-9362
	Customer Service (Home Sales/Small Business)	toll-free: 1-800-847-4096
	Customer Service (med./large business, government)	toll-free: 1-800-326-9463
	Customer Service (printers, projectors, televisions, handhelds, digital jukebox, and wireless)	toll-free: 1-800-847-4096
	Hardware Warranty Support (Home Sales/Small Business)	toll-free: 1-800-906-3355
	Hardware Warranty Support (med./large bus., government)	toll-free: 1-800-387-5757
	Hardware Warranty Support (printers, projectors, televisions, handhelds, digital jukebox, and wireless)	1-877-335-5767
	Sales (Home Sales/Small Business)	toll-free: 1-800-387-5752
	Sales (med./large bus., government)	toll-free: 1-800-387-5755
	Spare Parts Sales & Extended Service Sales	1 866 440 3355
Cayman Islands	General Support	1-800-805-7541
Chile (Santiago) Country Code: 56 City Code: 2	Sales and Customer Support	toll-free: 1230-020-4823
	Technical Support website: support.dell.com.cn	
	Technical Support E-mail: cn_support@dell.com	
	Customer Care E-mail: customer_cn@dell.com	
	Technical Support Fax	592 818 1350
	Technical Support (Dell™ Dimension™ and Inspiron)	toll-free: 800 858 2968
	Technical Support (OptiPlex™, Latitude™, and Dell Precision™)	toll-free: 800 858 0950
	Technical Support (servers and storage)	toll-free: 800 858 0960
	Technical Support (projectors, PDAs, switches, routers, and so on)	toll-free: 800 858 2920

China (Xiamen) Country Code: 86 City Code: 592	Technical Support (printers)	toll-free: 800 858 2311
	Customer Care	toll-free: 800 858 2060
	Customer Care Fax	592 818 1308
	Home and Small Business	toll-free: 800 858 2222
	Preferred Accounts Division	toll-free: 800 858 2557
	Large Corporate Accounts GCP	toll-free: 800 858 2055
	Large Corporate Accounts Key Accounts	toll-free: 800 858 2628
	Large Corporate Accounts North	toll-free: 800 858 2999
	Large Corporate Accounts North Government and Education	toll-free: 800 858 2955
	Large Corporate Accounts East	toll-free: 800 858 2020
	Large Corporate Accounts East Government and Education	toll-free: 800 858 2669
	Large Corporate Accounts Queue Team	toll-free: 800 858 2572
	Large Corporate Accounts South	toll-free: 800 858 2355
	Large Corporate Accounts West	toll-free: 800 858 2811
	Large Corporate Accounts Spare Parts	toll-free: 800 858 2621
Colombia	General Support	980-9-15-3978
Costa Rica	General Support	0800-012-0435
Czech Republic (Prague) International Access Code: 00 Country Code: 420	Website: support.euro.dell.com	
	E-mail: czech_dell@dell.com	
	Technical Support	22537 2727
	Customer Care	22537 2707
	Fax	22537 2714
	Technical Fax	22537 2728
	Switchboard	22537 2711
Denmark (Copenhagen) International Access Code: 00 Country Code: 45	Website: support.euro.dell.com	
	Technical Support for XPS	7010 0074
	Technical Support for all other Dell computers	7023 0182
	Customer Care (Relational)	7023 0184
	Home/Small Business Customer Care	3287 5505
	Switchboard (Relational)	3287 1200
	Switchboard Fax (Relational)	3287 1201
	Switchboard (Home/Small Business)	3287 5000
Switchboard Fax (Home/Small Business)	3287 5001	
Dominica	General Support	toll-free: 1-866-278-6821
Dominican Republic	General Support	1-800-148-0530
Ecuador	General Support	toll-free: 999-119
El Salvador	General Support	01-899-753-0777
Finland (Helsinki) International Access Code: 990 Country Code: 358 City Code: 9	Website: support.euro.dell.com	
	E-mail: fi_support@dell.com	
	Technical Support	0207 533 555
	Customer Care	0207 533 538
	Switchboard	0207 533 533
	Sales under 500 employees	0207 533 540
	Fax	0207 533 530
	Sales over 500 employees	0207 533 533
Fax	0207 533 530	
	Website: support.euro.dell.com	
	Home and Small Business	

France (Paris) (Montpellier) International Access Code: 00 Country Code: 33 City Codes: (1) (4)	Technical Support for XPS	0825 387 129
	Technical Support for all other Dell computers	0825 387 270
	Customer Care	0825 823 833
	Switchboard	0825 004 700
	Switchboard (calls from outside of France)	04 99 75 40 00
	Sales	0825 004 700
	Fax	0825 004 701
	Fax (calls from outside of France)	04 99 75 40 01
	Corporate	
	Technical Support	0825 004 719
	Customer Care	0825 338 339
	Switchboard	01 55 94 71 00
	Sales	01 55 94 71 00
	Fax	01 55 94 71 01
Germany (Langen) International Access Code: 00 Country Code: 49 City Code: 6103	Website: support.euro.dell.com	
	E-mail: tech_support_central_europe@dell.com	
	Technical Support for XPS	069 9792 7222
	Technical Support for all other Dell computers	069 9792-7200
	Home/Small Business Customer Care	0180-5-224400
	Global Segment Customer Care	06103 766-9570
	Preferred Accounts Customer Care	06103 766-9420
	Large Accounts Customer Care	06103 766-9560
	Public Accounts Customer Care	06103 766-9555
	Switchboard	06103 766-7000
Greece International Access Code: 00 Country Code: 30	Website: support.euro.dell.com	
	Technical Support	00800-44 14 95 18
	Gold Service Technical Support	00800-44 14 00 83
	Switchboard	2108129810
	Gold Service Switchboard	2108129811
	Sales	2108129800
	Fax	2108129812
Grenada	General Support	toll-free: 1-866-540-3355
Guatemala	General Support	1-800-999-0136
Guyana	General Support	toll-free: 1-877-270-4609
Hong Kong International Access Code: 001 Country Code: 852	Website: support.ap.dell.com	
	Technical Support E-mail: HK_support@Dell.com	
	Technical Support (Dimension and Inspiron)	2969 3188
	Technical Support (OptiPlex, Latitude, and Dell Precision)	2969 3191
	Technical Support (PowerApp™, PowerEdge™, PowerConnect™, and PowerVault™)	2969 3196
	Customer Care	3416 0910
	Large Corporate Accounts	3416 0907
	Global Customer Programs	3416 0908
	Medium Business Division	3416 0912
	Home and Small Business Division	2969 3105
India	E-mail: india_support_desktop@dell.com india_support_notebook@dell.com india_support_Server@dell.com	
	Technical Support	1600338045

		and 1600448046
	Sales (Large Corporate Accounts)	1600 33 8044
	Sales (Home and Small Business)	1600 33 8046
Ireland (Cherrywood) International Access Code: 00 Country Code: 353 City Code: 1	Website: support.euro.dell.com	
	E-mail: dell_direct_support@dell.com	
	Sales	
	Ireland Sales	01 204 4444
	Dell Outlet	1850 200 778
	Online Ordering HelpDesk	1850 200 778
	Customer Care	
	Home User Customer Care	01 204 4014
	Small Business Customer Care	01 204 4014
	Corporate Customer Care	1850 200 982
	Technical Support	
	Technical Support for XPS	1850 200 722
	Technical Support for all other Dell computers	1850 543 543
	At-Home-Service — Technical Support Queries	1850 200 889
	General	
	Fax/Sales Fax	01 204 0103
	Switchboard	01 204 4444
	U.K. Technical Support (dial within U.K. only)	0870 353 0800
	U.K. Customer Care (dial within U.K. only)	0870 353 0202
	Corporate Customer Care (dial within U.K. only)	0870 353 0240
U.K. Sales (dial within U.K. only)	0870 353 4000	
Italy (Milan) International Access Code: 00 Country Code: 39 City Code: 02	Website: support.euro.dell.com	
	Home and Small Business	
	Technical Support	02 577 826 90
	Customer Care	02 696 821 14
	Fax	02 696 821 13
	Switchboard	02 696 821 12
	Corporate	
	Technical Support	02 577 826 90
	Customer Care	02 577 825 55
	Fax	02 575 035 30
Switchboard	02 577 821	
Jamaica	General Support (dial from within Jamaica only)	1-800-682-3639
Japan (Kawasaki) International Access Code: 001 Country Code: 81 City Code: 44	Website: support.jp.dell.com	
	Technical Support (servers)	toll-free: 0120-198-498
	Technical Support outside of Japan (servers)	81-44-556-4162
	Technical Support (Dimension and Inspiron)	toll-free: 0120-198-226
	Technical Support outside of Japan (Dimension and Inspiron)	81-44-520-1435
	Technical Support (Dell Precision, OptiPlex, and Latitude)	toll-free:0120-198-433
	Technical Support outside of Japan (Dell Precision, OptiPlex, and Latitude)	81-44-556-3894
	Technical Support (PDAs, projectors, printers, routers)	toll-free: 0120-981-690
	Technical Support outside of Japan (PDAs, projectors, printers, routers)	81-44-556-3468
	Faxbox Service	044-556-3490
	24-Hour Automated Order Status Service	044-556-3801
Customer Care	044-556-4240	
Business Sales Division (up to 400 employees)	044-556-1465	

	Preferred Accounts Division Sales (over 400 employees)	044-556-3433
	Public Sales (government agencies, educational institutions, and medical institutions)	044-556-5963
	Global Segment Japan	044-556-3469
	Individual User	044-556-1760
	Switchboard	044-556-4300
Korea (Seoul) International Access Code: 001 Country Code: 82 City Code: 2	E-mail: krsupport@dell.com	
	Support	toll-free: 080-200-3800
	Support (Dimension, PDA, Electronics and Accessories)	toll-free: 080-200-3801
	Sales	toll-free: 080-200-3600
	Fax	2194-6202
	Switchboard	2194-6000
Latin America	Customer Technical Support (Austin, Texas, U.S.A.)	512 728-4093
	Customer Service (Austin, Texas, U.S.A.)	512 728-3619
	Fax (Technical Support and Customer Service) (Austin, Texas, U.S.A.)	512 728-3883
	Sales (Austin, Texas, U.S.A.)	512 728-4397
		512 728-4600
	SalesFax (Austin, Texas, U.S.A.)	or 512 728-3772
Luxembourg International Access Code: 00 Country Code: 352	Website: support.euro.dell.com	
	Support	342 08 08 075
	Home/Small Business Sales	+32 (0)2 713 15 96
	Corporate Sales	26 25 77 81
	Customer Care	+32 (0)2 481 91 19
	Fax	26 25 77 82
Macao Country Code: 853	Technical Support	toll-free: 0800 105
	Customer Service (Xiamen, China)	34 160 910
	Transaction Sales (Xiamen, China)	29 693 115
Malaysia (Penang) International Access Code: 00 Country Code: 60 City Code: 4	Website: support.ap.dell.com	
	Technical Support (Dell Precision, OptiPlex, and Latitude)	toll-free: 1 800 880 193
	Technical Support (Dimension, Inspiron, and Electronics and Accessories)	toll-free: 1 800 881 306
	Technical Support (PowerApp, PowerEdge, PowerConnect, and PowerVault)	toll-free: 1800 881 386
	Customer Care	toll-free: 1800 881 306 (option 6)
	Transaction Sales	toll-free: 1 800 888 202
	Corporate Sales	toll-free: 1 800 888 213
Mexico International Access Code: 00 Country Code: 52	Customer Technical Support	001-877-384-8979 or 001-877-269-3383
	Sales	50-81-8800 or 01-800-888-3355
	Customer Service	001-877-384-8979 or 001-877-269-3383
	Main	50-81-8800 or 01-800-888-3355
Montserrat	General Support	toll-free: 1-866-278-6822
Netherlands Antilles	General Support	001-800-882-1519
	Website: support.euro.dell.com	
	Technical Support for XPS	020 674 45 94
	Technical Support for all other Dell computers	020 674 45 00

Netherlands (Amsterdam) International Access Code: 00 Country Code: 31 City Code: 20	Technical Support Fax	020 674 47 66
	Home/Small Business Customer Care	020 674 42 00
	Relational Customer Care	020 674 4325
	Home/Small Business Sales	020 674 55 00
	Relational Sales	020 674 50 00
	Home/Small Business Sales Fax	020 674 47 75
	Relational Sales Fax	020 674 47 50
	Switchboard	020 674 50 00
	Switchboard Fax	020 674 47 50
New Zealand International Access Code: 00 Country Code: 64	Website: support.ap.dell.com	
	E-mail: support.ap.dell.com/contactus	
	General Support	0800 441 567
Nicaragua	General Support	001-800-220-1006
Norway (Lysaker) International Access Code: 00 Country Code: 47	Website: support.euro.dell.com	
	Technical Support for XPS	815 35 043
	Technical Support for all other Dell products	671 16882
	Relational Customer Care	671 17575
	Home/Small Business Customer Care	23162298
	Switchboard	671 16800
	Fax Switchboard	671 16865
Panama	General Support	001-800-507-0962
Peru	General Support	0800-50-669
Poland (Warsaw) International Access Code: 011 Country Code: 48 City Code: 22	Website: support.euro.dell.com	
	E-mail: pl_support_tech@dell.com	
	Customer Service Phone	57 95 700
	Customer Care	57 95 999
	Sales	57 95 999
	Customer Service Fax	57 95 806
	Reception Desk Fax	57 95 998
	Switchboard	57 95 999
Portugal International Access Code: 00 Country Code: 351	Website: support.euro.dell.com	
	Technical Support	707200149
	Customer Care	800 300 413
	Sales	800 300 410 or 800 300 411 or 800 300 412 or 21 422 07 10
	Fax	21 424 01 12
Puerto Rico	General Support	1-800-805-7545
St. Kitts and Nevis	General Support	toll-free: 1-877-441-4731
St. Lucia	General Support	1-800-882-1521
St. Vincent and the Grenadines	General Support	toll-free: 1-877-270-4609
Singapore (Singapore) International Access Code: 005 Country Code: 65	NOTE: The phone numbers in this section should be called from within Singapore or Malaysia only.	
	Website: support.ap.dell.com	
	Technical Support (Dimension, Inspiron, and Electronics and Accessories)	toll-free: 1 800 394 7430
	Technical Support (OptiPlex, Latitude, and Dell Precision)	toll-free: 1 800 394 7488
	Technical Support (PowerApp, PowerEdge, PowerConnect, and PowerVault)	toll-free: 1 800 394 7478

	Customer Care	toll-free: 1 800 394 7430 (option 6)
	Transaction Sales	toll-free: 1 800 394 7412
	Corporate Sales	toll-free: 1 800 394 7419
Slovakia (Prague) International Access Code: 00 Country Code: 421	Website: support.euro.dell.com	
	E-mail: czech_dell@dell.com	
	Technical Support	02 5441 5727
	Customer Care	420 22537 2707
	Fax	02 5441 8328
	Tech Fax	02 5441 8328
	Switchboard (Sales)	02 5441 7585
South Africa (Johannesburg) International Access Code: 09/091 Country Code: 27 City Code: 11	Website: support.euro.dell.com	
	E-mail: dell_za_support@dell.com	
	Gold Queue	011 709 7713
	Technical Support	011 709 7710
	Customer Care	011 709 7707
	Sales	011 709 7700
	Fax	011 706 0495
	Switchboard	011 709 7700
Southeast Asian and Pacific Countries	Technical Support, Customer Service, and Sales (Penang, Malaysia)	604 633 4810
Spain (Madrid) International Access Code: 00 Country Code: 34 City Code: 91	Website: support.euro.dell.com	
	Home and Small Business	
	Technical Support	902 100 130
	Customer Care	902 118 540
	Sales	902 118 541
	Switchboard	902 118 541
	Fax	902 118 539
	Corporate	
	Technical Support	902 100 130
	Customer Care	902 115 236
	Switchboard	91 722 92 00
	Fax	91 722 95 83
Sweden (Upplands Vasby) International Access Code: 00 Country Code: 46 City Code: 8	Website: support.euro.dell.com	
	Technical Support for XPS	0771 340 340
	Technical Support for all other Dell products	08 590 05 199
	Relational Customer Care	08 590 05 642
	Home/Small Business Customer Care	08 587 70 527
	Employee Purchase Program (EPP) Support	020 140 14 44
	Technical Support Fax	08 590 05 594
	Sales	08 590 05 185
Switzerland (Geneva) International Access Code: 00 Country Code: 41 City Code: 22	Website: support.euro.dell.com	
	E-mail: Tech_support_central_Europe@dell.com	
	Technical Support for XPS	0848 33 88 57
	Technical Support (Home and Small Business) for all other Dell products	0844 811 411
	Technical Support (Corporate)	0844 822 844
	Customer Care (Home and Small Business)	0848 802 202
	Customer Care (Corporate)	0848 821 721
	Fax	022 799 01 90
Switchboard	022 799 01 01	

Taiwan International Access Code: 002 Country Code: 886	Website: support.ap.dell.com	
	E-mail: ap_support@dell.com	
	Technical Support (OptiPlex, Latitude, Inspiron, Dimension, and Electronics and Accessories)	toll-free: 00801 86 1011
	Technical Support (PowerApp, PowerEdge, PowerConnect, and PowerVault)	toll-free: 00801 60 1256
	Customer Care	toll-free: 00801 60 1250 (option 5)
	Transaction Sales	toll-free: 00801 65 1228
	Corporate Sales	toll-free: 00801 651 227
Thailand International Access Code: 001 Country Code: 66	Website: support.ap.dell.com	
	Technical Support (OptiPlex, Latitude, and Dell Precision)	toll-free: 1800 0060 07
	Technical Support (PowerApp, PowerEdge, PowerConnect, and PowerVault)	toll-free: 1800 0600 09
	Customer Care	toll-free: 1800 006 007 (option 7)
	Corporate Sales	toll-free: 1800 006 009
	Transaction Sales	toll-free: 1800 006 006
Trinidad/Tobago	General Support	1-800-805-8035
Turks and Caicos Islands	General Support	toll-free: 1-866-540-3355
U.K. (Bracknell) International Access Code: 00 Country Code: 44 City Code: 1344	Website: support.euro.dell.com	
	E-mail: dell_direct_support@dell.com	
	Customer Care website: support.euro.dell.com/uk/en/ECare/form/home.asp	
	Sales	
	Home and Small Business Sales	0870 907 4000
	Corporate/Public Sector Sales	01344 860 456
	Customer Care	
	Home and Small Business Customer Care	0870 906 0010
	Corporate Customer Care	01344 373 185
	Preferred Accounts (500–5000 employees) Customer Care	0870 906 0010
	Global Accounts Customer Care	01344 373 186
	Central Government Customer Care	01344 373 193
	Local Government & Education Customer Care	01344 373 199
	Health Customer Care	01344 373 194
	Technical Support	
	Technical Support for XPS	0870 366 4180
	Technical Support (Corporate/Preferred Accounts/PAD [1000+ employees])	0870 908 0500
	General	
	Technical Support for all other products	0870 908 0800
	Home and Small Business Fax	0870 907 4006
Uruguay	General Support	toll-free: 000-413-598-2521
	Automated Order-Status Service	toll-free: 1-800-433-9014
	AutoTech (portable and desktop computers)	toll-free: 1-800-247-9362
	Hardware and Warranty Support (Dell TV, Printers, and Projectors) for Relationship customers	toll-free: 1-877-459-7298
	Americas Consumer XPS Support	toll-free: 1-800-232-8544
	Consumer (Home and Home Office) Support for all other Dell products	toll-free: 1-800-624-9896
	Customer Service	toll-free: 1-800-624-9897
	Employee Purchase Program (EPP) Customers	toll-free: 1-800-695-8133
	Financial Services website: www.dellfinancialservices.com	
	Financial Services (lease/loans)	toll-free: 1-877-577-3355

U.S.A. (Austin, Texas) International Access Code: 011 Country Code: 1	Financial Services (Dell Preferred Accounts [DPA])	toll-free: 1-800-283-2210
	Business	
	Customer Service and Support	toll-free: 1-800-456-3355
	Employee Purchase Program (EPP) Customers	toll-free: 1-800-695-8133
	Support for printers, projectors, PDAs, and MP3 players	toll-free: 1-877-459-7298
	Public (government, education, and healthcare)	
	Customer Service and Support	toll-free: 1-800-456-3355
	Employee Purchase Program (EPP) Customers	toll-free: 1-800-695-8133
	Dell Sales	toll-free: 1-800-289-3355 or toll-free: 1-800-879-3355
	Dell Outlet Store (Dell refurbished computers)	toll-free: 1-888-798-7561
	Software and Peripherals Sales	toll-free: 1-800-671-3355
	Spare Parts Sales	toll-free: 1-800-357-3355
	Extended Service and Warranty Sales	toll-free: 1-800-247-4618
	Fax	toll-free: 1-800-727-8320
	Dell Services for the Deaf, Hard-of-Hearing, or Speech-Impaired	toll-free: 1-877-DELLTY (1-877-335-5889)
U.S. Virgin Islands	General Support	1-877-673-3355
Venezuela	General Support	8001-3605

[Back to Contents Page](#)

[Back to Contents Page](#)

Getting Help: Dell™ PowerVault™ LTO4-120HH Tape Drive User's Guide

- [Technical Assistance](#)
 - [Dell Enterprise Training and Certification](#)
 - [Problems With Your Order](#)
 - [Product Information](#)
 - [Returning Items for Warranty Repair or Credit](#)
 - [Before You Call](#)
-

Technical Assistance

If you need assistance with a technical problem, perform the following steps:

1. Complete the procedures in "Troubleshooting Your System."
2. Run the system diagnostics and record any information provided.
3. Make a copy of the [Diagnostics Checklist](#), and fill it out.
4. Use Dell's extensive suite of online services available at Dell Support at support.dell.com for help with installation and troubleshooting procedures.

For more information, see "Online Services."

5. If the preceding steps have not resolved the problem, call Dell for technical assistance.

NOTE: Call technical support from a phone near or at the system so that technical support can assist you with any necessary procedures.

NOTE: Dell's Express Service Code system may not be available in all countries.

When prompted by Dell's automated telephone system, enter your Express Service Code to route the call directly to the proper support personnel. If you do not have an Express Service Code, open the **Dell Accessories** folder, double-click the **Express Service Code** icon, and follow the directions.

For instructions on using the technical support service, see "[Technical Support Service](#)" and "[Before You Call](#)."

NOTE: Some of the following services are not always available in all locations outside the continental U.S. Call your local Dell representative for information on availability.

Online Services

You can access Dell Support at support.dell.com. Select your region on the **WELCOME TO DELL SUPPORT** page, and fill in the requested details to access help tools and information.

You can contact Dell electronically using the following addresses:

- 1 World Wide Web

www.dell.com/

www.dell.com/ap/ (Asian/Pacific countries only)

www.dell.com.cn (China only)

www.dell.com/jp (Japan only)

www.euro.dell.com (Europe only)

www.dell.com/la (Latin American countries)

www.dell.ca (Canada only)

- 1 Anonymous file transfer protocol (FTP)

ftp.dell.com/

Log in as user:anonymous, and use your e-mail address as your password.

- 1 Electronic Support Service

support@us.dell.com

apsupport@dell.com (Asian/Pacific countries only)

cn_support@dell.com (China only)

support.jp.dell.com (Japan only)

support.euro.dell.com (Europe only)

- 1 Electronic Quote Service

sales@dell.com

apmarketing@dell.com (Asian/Pacific countries only)

sales_canada@dell.com (Canada only)

- 1 Electronic Information Service

info@dell.com

AutoTech Service

Dell's automated technical support service AutoTech provides recorded answers to the questions most frequently asked by Dell customers about their portable and desktop computer systems.

When you call AutoTech, use your touch-tone telephone to select the subjects that correspond to your questions.

The AutoTech service is available 24 hours a day, 7 days a week. You can also access this service through the technical support service. See the contact information for your region.

Automated Order-Status Service

To check on the status of any Dell products that you have ordered, you can go to support.dell.com, or you can call the automated order-status service. A recording prompts you for the information needed to locate and report on your order. See the contact information for your region.

Technical Support Service

Dell's technical support service is available 24 hours a day, 7 days a week, to answer your questions about Dell hardware. Our technical support staff use computer-based diagnostics to provide fast, accurate answers.

To contact Dell's technical support service, see "[Before You Call](#)" and then see the contact information for your region.

Dell Enterprise Training and Certification

Dell Enterprise Training and Certification is available; see www.dell.com/training for more information. This service may not be offered in all locations.

Problems With Your Order

If you have a problem with your order, such as missing parts, wrong parts, or incorrect billing, contact Dell for customer assistance. Have your invoice or packing slip available when you call. See the contact information for your region.

Product Information

If you need information about additional products available from Dell, or if you would like to place an order, visit the Dell website at www.dell.com. For the telephone number to call to speak to a sales specialist, see the contact information for your region.

Returning Items for Warranty Repair or Credit

Prepare all items being returned, whether for repair or credit, as follows:

1. Call Dell to obtain a Return Material Authorization Number, and write it clearly and prominently on the outside of the box.

For the telephone number to call, see the contact information for your region.

2. Include a copy of the invoice and a letter describing the reason for the return.
3. Include a copy of any diagnostic information (including the Diagnostics Checklist) indicating the tests you have run and any error messages reported by the system diagnostics.
4. Include any accessories that belong with the item(s) being returned (such as power cables, media such as CDs and diskettes, and guides) if the return is for credit.
5. Pack the equipment to be returned in the original (or equivalent) packing materials.

You are responsible for paying shipping expenses. You are also responsible for insuring any product returned, and you assume the risk of loss during shipment to Dell. Collect-on-delivery (C.O.D.) packages are not accepted.

Returns that are missing any of the preceding requirements will be refused at our receiving dock and returned to you.

Before You Call

NOTE: Have your Express Service Code ready when you call. The code helps Dell's automated-support telephone system direct your call more efficiently.

Remember to fill out the [Diagnostics Checklist](#). If possible, turn on your system before you call Dell for technical assistance and call from a telephone at or near the computer. You may be asked to type some commands at the keyboard, relay detailed information during operations, or try other troubleshooting steps possible only at the computer system itself. Ensure that the system documentation is available.

 **CAUTION: Before servicing any components inside your computer, see your *System Information Guide* for important safety information.**

Diagnostics Checklist
Name:
Date:
Address:
Phone number:
Service Tag (bar code on the back of the computer):
Express Service Code:
Return Material Authorization Number (if provided by Dell support technician):
Operating system and version:
Peripherals:
Expansion cards:
Are you connected to a network? Yes No
Network, version, and network card:
Programs and versions:

See your operating system documentation to determine the contents of the system's start-up files. If possible, print each file. Otherwise, record the contents of each file before calling Dell.

Error message, beep code, or diagnostic code:

Description of problem and troubleshooting procedures you performed:

[Back to Contents Page](#)

Glossary: Dell™ PowerVault™ LTO4-120HH Tape Drive User's Guide

- [A](#) - [B](#) - [C](#) - [D](#) - [E](#) - [F](#) - [G](#) - [H](#) - [I](#) - [J](#) - [L](#) - [M](#) - [N](#) - [O](#) - [P](#) - [R](#) - [S](#) - [T](#) - [U](#) - [V](#) - [W](#)

Numbers

2:1 compression. The relationship between the quantity of data that can be stored with compression as compared to the quantity of data that can be stored without compression. In 2:1 compression, twice as much data can be stored with compression as can be stored without compression.

A

A. See **ampere**.

ampere (A). A unit of measure for electric current that is equivalent to a flow of one coulomb per second, or equivalent to the current produced by one volt applied across a resistance of one ohm.

adapter. See **adapter card**.

adapter card. A circuit board that adds function to a computer.

B

backups. The short-term retention of records used for restoring essential business and server files when vital data has been lost because of program or server errors or malfunctions.

backward compatible. Capable of being used with a previous product that was designed for a similar purpose. For example, a tape cartridge that is designed to be used with a modern tape drive but can also be used with certain older tape drives. Synonymous with *downward compatible*.

bezel. The removable frame that fits over the front of the tape drive.

burst data transfer rate. The maximum speed at which data is transferred.

byte. A string that consists of a certain number of bits (usually 8) which are treated as a unit and represent a character. A byte is a fundamental unit of data.

C

C. See **Celsius**.

capacity. The amount of data that can be contained on storage media and expressed in bytes.

cartridge. See **tape cartridge**.

cartridge door. On a tape cartridge, the hinged barrier that can be opened to access, or closed to protect, the magnetic tape within the cartridge.

cartridge memory. See **LTO cartridge memory**.

Celsius (C). Having a thermostatic scale on which the interval between the freezing point and the boiling point of water is divided into 100 degrees, with 0 degrees representing the freezing point and 100 degrees representing the boiling point.

cleaning cartridge. A tape cartridge that is used to clean the heads of a tape drive. Contrast with *data cartridge*.

clockwise. In the direction that the hands of a clock rotate, as viewed from the front.

compression. The process of eliminating gaps, empty fields, redundancies, and unnecessary data to shorten the length of records or blocks.

configure. To describe to a server the devices, optional features, and programs installed on the system.

counterclockwise. In a direction opposite to that in which the hands of a clock rotate, as viewed from the front.

current. The quantity of charge per unit of time. Current is measured in amperes.

cycle power. To apply and remove electrical power to a device within a short time span.

D

data. Any representations such as characters or analog quantities to which meaning is, or might be, assigned.

data cartridge. A tape cartridge that is dedicated to storing data. Contrast with cleaning cartridge.

data compression. See **compression**.

data transfer rate. The average number of bits, characters, or blocks per unit of time that pass between corresponding equipment in a data transmission system. The rate is expressed in bits, characters, or blocks per second, minute, or hour.

DC. See **direct current**.

degauss. To make a magnetic tape nonmagnetic by exposing the tape to electrical coils which carry currents that neutralize the magnetism of the tape.

device. Any hardware component or peripheral, such as a tape drive or tape library, that can receive and send data.

device driver. A file that contains the firmware that is needed to use an attached device.

diagnostic. A software program that is designed to recognize, locate, and explain faults in equipment or errors in programs.

direct current (DC). An electric current flowing in one direction only and substantially constant in value.

drive. A data-storage device that controls the movement of the magnetic tape in a tape cartridge. The drive houses the mechanism (drive head) that reads and writes data to the tape.

drive dump. The recording, at a particular instant, of the contents of all or part of one storage device into another storage device, usually as a safeguard against faults or errors, or in connection with debugging.

drive head. The component that records an electrical signal onto magnetic tape, or reads a signal from tape into an electrical signal.

drive sense data. See **SCSI drive sense data**.

dump. See **drive dump**.

E

eject. To remove or force out from within.

enclosure. A device, such as a desktop unit, tape cartridge autoloader, or tape library, into which you can install the tape drive.

error log. Maintained by the tape drive, a list that contains the ten most recent error codes. The codes identify errors that pertain to the drive.

F

F. See **Fahrenheit**.

Fahrenheit (F). Of or relating to a temperature scale that registers the freezing point of water as 32 degrees and the boiling point as 212 degrees at one atmosphere of pressure.

file. A named set of records that are stored or processed as a unit.

firmware. The proprietary code that is usually delivered as part of an operating system. Firmware is more efficient than software that is loaded from an alterable medium, and is more adaptable to change than pure hardware circuitry. An example of firmware is the Basic Input/Output System (BIOS) in read-only memory (ROM) on a PC motherboard.

G

GB. See **gigabyte**.

Generation 1. The informal name for the Ultrium tape drive, which is the predecessor of the tape drive (Generation 2). The Generation 1 drive has a native storage capacity of up to 100 GB per cartridge and a native sustained data transfer rate of 15 MB per second.

Generation 2. The informal name for the Ultrium 2 Tape Drive, which is the second-generation version of the Ultrium tape drive (Generation 1). The Generation 2 drive has a native storage capacity of up to 200 GB per cartridge and a native sustained data transfer rate of 35 MB per second.

Generation 3. The informal name for the Ultrium 3 Tape Drive, which is the third-generation version of the Ultrium tape drive (Generation 1, 2). The Generation 3 drive has a native storage capacity of up to 400 GB per cartridge and a native sustained data transfer rate of 80 MB per second.

Generation 4. The informal name for the Ultrium 4 Tape Drive, which is the fourth-generation version of the Ultrium tape drive (Generation 1, 2, 3). The Generation 4 drive has a native storage capacity of up to 800 GB per cartridge and a native sustained data transfer rate of 120 MB per second.

gigabyte. 1,000,000,000 bytes.

ground. An object that makes an electrical connection with the earth.

H

hardware. The physical equipment or devices that form a computer.

head. See **drive head**.

Head Resistance Measurements test. Part of the Test Head diagnostic, a procedure that determines whether the tape drive's head works correctly. The test measures the head's ability to withstand cracks and other defects.

host. The controlling or highest-level system in a data communication configuration. Synonymous with *server*.

I

ID. Identifier.

in. See **inch**.

inch. A unit of length equal to 1/36 yard or 25.4 mm.

input/output (I/O). Data that is provided to a computer or data that results from computer processing.

insertion guide. On the surface of the tape cartridge, a large, notched area that prevents you from inserting the cartridge incorrectly.

install. (1) To set up for use or service. (2) The act of adding a product, feature, or function to a server or device either by a singular change or by the addition of multiple components or devices.

interposer. An adapter-like device that allows a connector of one size and style to connect to a mating connector of a different size and style. Data provided to the computer or data resulting from computer processing.

I/O. See **input/output**.

J

jumper. (1) A tiny connector that fits over a pair of protruding pins in a connector. A jumper can be moved to change electrical connectors. When in place, the jumper connects the pins electrically.

(2) To place a jumper on a connector pin.

L

label. A slip of paper with an adhesive backing that can be written on and affixed to a tape cartridge as a means of identification or description.

label area. On the LTO Ultrium Tape Cartridge, a recessed area next to the write-protect switch where a bar code label must be affixed.

leader block. Located within the tape drive, the part that engages the steel pin which is attached to the tape in an LTO Ultrium Tape Cartridge. Once engaged, the leader-pin block pulls the tape from the cartridge into the drive.

leader pin. On the tape cartridge, a small metal column that is attached to the end of the magnetic tape. During tape processing the leader pin is grasped by a threading mechanism, which pulls the pin and the tape out of the cartridge, across the drive head, and onto a takeup reel. The head can then read or write data from or to the tape.

LED. See **light-emitting diode**.

light-emitting diode. A semiconductor diode that emits light when subjected to an applied voltage and that is used in an electronic display.

Linear Tape-Open (LTO). A type of tape storage technology developed by the IBM Corporation, Hewlett-Packard, and Seagate. LTO technology is an "open format" technology, which means that its users have multiple sources of product and media. The "open" nature of LTO technology enables compatibility between

different vendors' offerings by ensuring that vendors comply with verification standards.

load. Following the insertion of a tape cartridge into the tape load compartment, the act of positioning the tape (performed by the tape drive) for reading or writing by the drive's head.

log sense data. See **SCSI log sense data**.

loop. (1) A series of instructions that is repeated until a terminating condition is reached.
(2) To connect so as to complete a loop.

LTO. See **Linear Tape-Open**.

M

magnetic tape. A tape with a magnetizable surface layer on which data can be stored by magnetic recording.

maintenance mode. The state of operation in which the tape drive must be before it can run diagnostics, verify write and read operations, verify a suspect tape cartridge, update its own firmware, and perform other diagnostic and maintenance functions.

MB. See **megabyte**.

media. The plural of *medium*.

medium. A physical material in or on which data may be represented, such as magnetic tape.

megabyte (MB). 1,000,000 bytes.

N

network. A configuration of data processing devices and software that is connected for information interchange.

O

oersted. The unit of magnetic field strength in the unrationalized centimeter-gram-second (cgs) electromagnetic system. The oersted is the magnetic field strength in the interior of an elongated, uniformly wound solenoid that is excited with a linear current density in its winding of one ampere per 4 pi centimeters of axial length.

offline. The operating condition that the tape drive is in when the server's applications cannot interact with it.

online. The operating condition that the tape drive is in when the server's applications can interact with it.

Open Systems. Computer systems whose standards are not proprietary.

operating environment. The temperature, relative humidity rate, and wet bulb temperature of the room in which the tape drive routinely conducts processing.

P

parity. The state of being even-numbered or odd-numbered. A parity bit is a binary number that is added to a group of binary numbers to make the sum of that group always odd (odd parity) or even (even parity).

parity error. A transmission error that occurs when the received data does not have the parity that is expected by the receiving system. This usually occurs when the sending and receiving systems have different parity settings.

port. (1) A system or network access point for data entry or exit.
(2) A connector on a device to which cables for other devices such as display stations and printers are attached.
(3) The representation of a physical connection to hardware. A port is sometimes referred to as an adapter; however, there can be more than one port on an adapter.

power connector. Located at the rear of the tape drive, the connector to which the internal power cable of an enclosure connects.

power cord. A cable that connects a device to a source of electrical power.

power-off. To remove electrical power from a device.

power-on, powered-on. (1) To apply electrical power to a device.
(2) The state of a device when power has been applied to it.

R

read. To acquire or interpret data from a storage device, from a data medium, or from another source.

reboot. To reinitialize the execution of a program by repeating the initial program load (IPL) operation.

record. The smallest distinct set of data bytes that is supplied from a server for processing and recording by a tape drive, and the smallest distinct set of data to be read from tape, reprocessed, and made available to a server by a tape drive.

relative humidity. The ratio of the amount of water vapor actually present in the air to the greatest amount possible at the same temperature.

reset. To return a device or circuit to a clear state.

S

SAS Serial Attached SCSI (SAS) Interface

scratch cartridge. A data cartridge that contains no useful data, but can be written to with new data.

SCSI. See **Small Computer Systems Interface.**

(2) A generic term that refers to the complete set of signals that define the activity of the Small Computer Systems Interface (SCSI).

SCSI drive sense data. In response to inquiry from the server about an error condition, a packet of SCSI sense bytes that contains information about the error and that is sent back to the server by the drive.

SCSI log sense data. In response to inquiry from the server about the tape drive's error logs and counters, a packet of SCSI sense bytes which contains that information and which is sent back to the server by the drive. Log sense data is used to diagnose problems, especially if the problems are intermittent.

second. One sixtieth of a minute.

sense data. Data that describes an I/O error. Sense data is presented to a server in response to a Sense I/O command.

server. A functional unit that provides services to one or more clients over a network. Examples include a file server, a print server, or a mail server. Synonymous with host.

single-character display. Located at the front of the tape drive, an LED that presents an alphabetical or numeric code which represents a diagnostic or maintenance function, error condition, or informational message.

sleep mode. A power-management function that causes the tape drive's electronics to automatically enter a low-power mode by which to conserve energy.

Small Computer Systems Interface (SCSI). A standard used by computer manufacturers for attaching peripheral devices (such as tape drives, hard disks, CD-ROM players, printers, and scanners) to computers (servers). Pronounced "scuzzy." Variations of the SCSI interface provide for faster data transmission rates than standard serial and parallel ports (up to 160 megabytes per second). The variations include:

- 1 Fast/Wide SCSI: Uses a 16-bit bus, and supports data rates of up to 20 MBps.
- 1 SCSI-1: Uses an 8-bit bus, and supports data rates of 4 MBps.
- 1 SCSI-2: Same as SCSI-1, but uses a 50-pin connector instead of a 25-pin connector, and supports multiple devices.
- 1 Ultra SCSI: Uses an 8- or 16-bit bus, and supports data rates of 20 or 40 MBps.
- 1 Ultra2 SCSI: Uses an 8- or 16-bit bus and supports data rates of 40 or 80 MBps.
- 1 Ultra3 SCSI: Uses a 16-bit bus and supports data rates of 80 or 160 MBps.
- 1 Ultra160 SCSI: Uses a 16-bit bus and supports data rates of 160 MBps.

software. Programs, procedures, rules, and any associated documentation pertaining to the operation of a computer system.

speed matching. A technique used by the tape drive to dynamically adjust its native (uncompressed) data rate to the slower data rate of a server. Speed matching improves system performance and reduces backhitch.

T

TapeAlert. A patented technology and ANSI standard that defines conditions and problems that are experienced by tape drives.

TapeAlert flags. Status and error messages that are generated by the TapeAlert utility and display on the server's console.

tape cartridge. A removable storage case that houses belt-driven magnetic tape that is wound on a supply reel and a takeup reel.

tape drive. A data-storage device that controls the movement of the magnetic tape in a tape cartridge. The Dell PowerVault LTO4-120HH tape drive houses the mechanism (drive head) that reads and writes data to the tape. Its native data capacity is 800 GB per cartridge; with 2:1 compression, its capacity is up to 1600 GB.

tape path. Within a tape drive, the channel in which the media moves.

V

VDC. Volts DC (direct current).

volt. The SI (international) unit of potential difference and electromotive force. Formally defined as the difference of electric potential between two points of a conductor that carries a constant current of one ampere when the power dissipated between these points is equal to one watt.

W

wet bulb temperature. The temperature at which pure water must be evaporated adiabatically at constant pressure into a given sample of air in order to saturate the air under steady-state conditions. Wet bulb temperature is read from a wet bulb thermometer.

write. To make a permanent or transient recording of data in a storage device or on a data medium.

write protected. Applicable to a tape cartridge, the condition that exists when some logical or physical mechanism prevents a device from writing on the tape in that cartridge.

write-protect switch. Located on the tape cartridge, a switch that prevents accidental erasure of data. Pictures of a locked and unlocked padlock appear on the switch. When you slide the switch to the locked padlock, data cannot be written to the tape. When you slide the switch to the unlocked padlock, data can be written to the tape.

Write/Read test. Part of the Test Head diagnostic, a procedure that determines whether the tape drive can correctly read from and write to tape.

[Back to Contents Page](#)

[Back to Contents Page](#)

Introduction: Dell™ PowerVault™ LTO4-120HH Tape Drive User's Guide

- [Overview](#)
 - [Serial Attached SCSI \(SAS\) Interface](#)
 - [Encryption](#)
 - [Features](#)
 - [Tape Backup Software](#)
 - [Front Panel](#)
 - [Rear Panel](#)
-

Overview

The Dell PowerVault LTO4-120HH tape drive is a high-performance, high-capacity tape storage device that is designed to back up and restore data and archive and retrieve files in an Open Systems environment. The drive can be integrated into a system (internal model) or can be provided as a separately packaged desktop unit (external model). The Dell PowerVault LTO4-120HH tape drive (called Generation 4) is the fourth-generation tape drive in the LTO series of products.

The Dell PowerVault LTO4-120HH tape drive offers a formatted cartridge capacity of up to 800 GB (1600 GB assuming 2:1 compression ratio) and a maximum data transfer rate of 120 MB per second.

Figure 1 shows the internal model of the LTO4-120HH tape drive. Figure 2 shows the separately purchased external model of the tape drive.

Figure 1. LTO4-120HH Internal Model

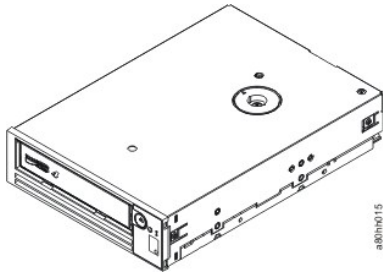
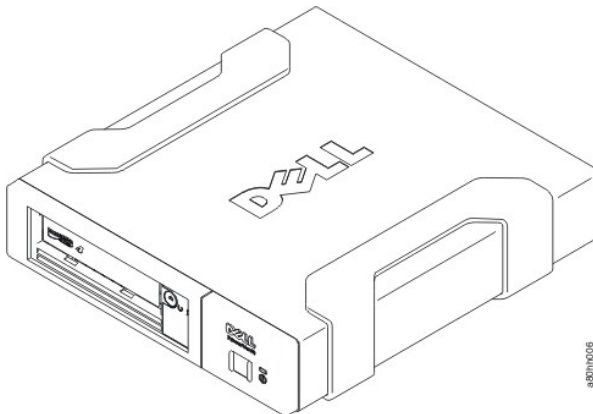

Figure 2. LTO4-120HH External Model



Serial Attached SCSI (SAS) Interface

A drive with a SAS (Serial Attached SCSI) interface can be linked directly to controllers. The SAS interface offers the following advantages over the traditional SCSI interface:

- 1 SAS enables multiple devices (up to 128) of different sizes and types to be connected simultaneously with thinner and longer cables.
- 1 Its full-duplex signal transmission supports up to 3.0 Gb/s.
- 1 SAS drives can be hot-plugged.

Encryption

The LTO4-120HH Tape Drive has Application Managed Encryption (AME) functionality. AME is supported on Windows Server 2003. You must have an application that supports encryption to use the drives encryption capability. For more details, consult your application support documentation.

Features

The tape drive has the following features:

- 1 Capacity of 800 GB (native), 1600 GB (compressed*) on a single LTO Ultrium 4 tape cartridge
- 1 Built-in read-after-write verification for a high level of data integrity
- 1 Maximum Data transfer rate of 120 MB per second (native)
- 1 Burst data transfer rate of 300 MB per second
- 1 256 MB of read/write cache memory
- 1 Intelligent LTO-DC dual-mode compression algorithm
- 1 Failsafe leader capture mechanism with pin pick error recovery
- 1 Reads cartridge memory in LTO cartridges
- 1 TapeAlert support for improved diagnostic and troubleshooting
- 1 Internal drive: 3 Gb Serial Attached SCSI interface
- 1 External drive: 3 Gb Serial Attached SCSI interface
- 1 Speed matching (The drive can slow down to 30 MB per second minimum to match the system data rate.)
- 1 Sleep mode for energy conservation
- 1 Backward read and write compatibility with Generation 3 cartridges
- 1 Backward read compatibility with Generation 2 cartridges (does not read or write Generation 1 cartridges)
- 1 Compatible with all cartridges that bear the official Ultrium LTO logo
- 1 Will interchange tapes with other LTO tape drives that bear the official Ultrium LTO logo
- 1 Support for WORM (Write Once Read Many) using WORM media
- 1 Data encryption capability using LTO Ultrium 4 media

* Assumes 2:1 compression. The capacity and transfer rate you realize in practice depends on the data set, which affects the actual compression ratio.

Tape Backup Software

You need backup software that supports the Dell PowerVault LTO4-120HH tape drive. As a general rule, native backup applications (such as NTBackup and tar) do not provide the required data streaming rate to get the full performance of your tape drive. It is recommend that you use a backup application that provides better memory management as well as other useful features, such as TapeAlert. For the latest supported software versions, go to the Dell support website at support.dell.com or visit the support site of your backup software vendor.

Front Panel

Figure 3. Front Panel

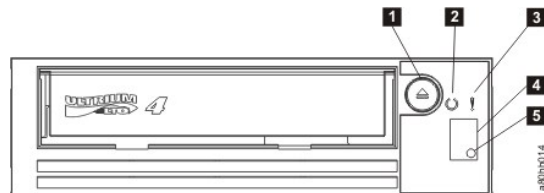

- 1. Eject button
- 2. Ready/Activity LED
- 3. Fault LED
- 4. Single-character display (SCD)
- 5. Single red dot

1. Eject button. The eject button enables you to perform several functions. These functions are described in detail in "[Using the Tape Drive.](#)"



2. Ready/Activity LED. The front panel of your Dell PowerVault LTO4-120HH tape drive has a green Ready/Activity LED providing information about the state of the tape drive. The LED can be solid on or flashing when lit. See Table 1 for more descriptions.

3. Fault LED. The front panel of your Dell PowerVault LTO4-120HH tape drive has an amber fault LED indicating the drive has encountered an error, is not in a normal operational status, or needs cleaning. See table 1 for more detailed description.

4. Single-character display. This LED presents a single-character code for diagnostic/maintenance functions, error conditions, and informational messages.

5. Single red dot. This single-character display is blank during normal operation. When a single red dot illuminates and flashes on the display, the drive has created a dump of vital technical data to drive memory.

Table 1. SCD, Ready/Activity LED, and Fault LED Descriptions

Condition of green Ready/Activity LED	Condition of amber Fault LED	Condition of the SCD Panel	Condition of the SCD Dot	Meaning of LEDs and SCD Panel and SCD Dot
Off	Off	Off	Off	The tape drive has no power or is powered off.
On Solid	Off	Off or 	Off	The tape drive is powered on or (if a solid  displays in the single character display) needs cleaning.
Flashing once per second	Off	Off	Off	The tape drive is reading from the tape, writing to the tape, rewinding the tape, locating data on the tape, loading the tape, or unloading the tape. The Ready/Activity LED also flashes green if the tape drive contains a cartridge during the power on cycle. In this case, the drive completes POST and slowly rewinds the tape (this process may take approximately 13 minutes). The Ready/Activity LED stops blinking when the drive completes the recovery and is ready for a read or write operation. To eject the cartridge, press the unload button.
Off	On/Solid	On Solid	On/Off	The tape drive is in maintenance mode or is displaying an error code on the SCD in maintenance mode option 9.
Off	On Solid	Flashing once per second	On/Off	Executing the selected option while in maintenance mode.
Off	Flashing once per second	On Solid	Off	An error occurred and the tape drive or media may require service or drive may require cleaning. Note the code on the single character display, and then go to the error code table in the troubleshooting section to determine the meaning of the error codes. If a  appears on the SCD, a cleaning cartridge must be loaded.
Off	Flashing twice per second	Off	Off	The drive is updating firmware.
Off	Flashing once every 2 seconds	Off	Off	The drive detected an error and is performing a firmware recovery. It will reset automatically.

Rear Panel

Figure 4. Rear Panel of Internal SAS Tape Drive

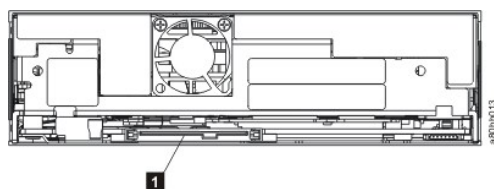

1. SAS connector

Figure 5. Rear Panel of External SAS Tape Drive

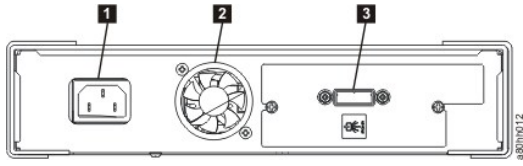

1. Power connector
2. Fan enclosure
3. SAS connector

[Back to Contents Page](#)

[Back to Contents Page](#)

Setting Up the Tape Drive: Dell™ PowerVault™ LTO4-120HH Tape Drive User's Guide

- [Pre-installed Internal Drives](#)
 - [Installing Internal Drives](#)
 - [Installing External Drives](#)
 - [Loading Device Drivers](#)
 - [Verifying Drive Operation](#)
-

Pre-installed Internal Drives

Dell performs the installation and setup of internal tape drives that are shipped as part of a system. If tape backup software is included in your system, refer to the installation instructions included with the software.

For the latest supported software versions, go to the Dell support website support.dell.com or visit the support site of your backup software vendor.

Installing Internal Drives

If your internal tape drive is not pre-installed, the installation instructions are described in the following sections:

Installing the Drive — Prerequisites

The Dell PowerVault LTO4-120HH tape drive is a 3 Gb SAS device with a burst transfer rate of 300 MB per second. It is recommended that you use a dedicated SAS host bus adapter for this tape drive.

Mounting Bay

You need one industry-standard, 5 1/4 inch, half-height bay in which to install the PowerVault LTO4-120HH tape drive. The drive may be mounted vertically or horizontally.

Install and configure the drive according to the instructions provided in the Dell documentation for your system.

Mounting Hardware

Most systems use trays or rails to mount the tape drive. If the mounting hardware is pre-installed, you can simply slide the drive into the mounting bay. Some systems do not use slides or rails and drives must be fixed in place with screws.

Installing the Drive — Step-By-Step Instructions

Step 1 — Unpacking the Drive

Unpack the tape drive and store the packaging. You may need the packaging if you return the unit for service.

A period of time is required if the temperature of the drive when unpacked is different than the temperature of its operating environment (measured at the front of the bezel near the air intake area; see number 1 in [Figure 6](#)). The recommended time is 4 hours after the drive has been unpacked or 1 hour after any condensation that you can see has evaporated, whichever is greater. To allow the drive to adjust to its new environment, apply the following measures:

- 1 If the drive is colder than its operating environment and the air contains sufficient humidity, condensation may occur in the drive and damage it. When the drive has warmed to the operating temperature range (greater than 10 degrees C or 50 degrees F) and no danger of condensation is present (the air is dry), warm the drive more quickly by powering it on for 30 minutes. Use a scratch tape to test the drive before inserting a tape that contains data.
- 1 If the drive is hotter than its operating environment, the tape can stick to the drive head. When the drive has cooled to the operating temperature range (less than 40 degrees C or 104 degrees F), cool the drive more quickly by applying airflow for 30 minutes. Power on the drive and use a scratch tape to test it before inserting a tape that contains data.

If you are uncertain about whether the temperature of the drive is within the recommended operating range or the humidity is sufficient to cause condensation, allow the drive to adjust to its new environment for the full 4 hours.

Figure 6. Air Intake Area

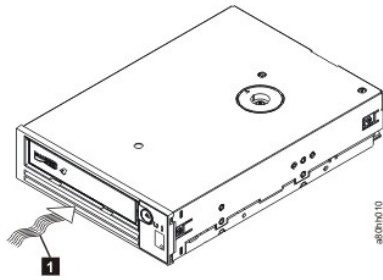

1. Air Intake Area

Step 2 — Removing Power from the System

1. Power-off the system.
2. Disconnect the power cord from both the electrical outlet and the system.

Step 3 — Preparing the Mounting Bay in Your System

CAUTION: To avoid personal injury or damage to the system or tape drive, ensure that the system power cord is disconnected before you install the drive.

Refer to your system's documentation for instructions on how to prepare the mounting bay to receive the tape drive.

Step 4 — Attaching Mounting Hardware

If your system requires special rails or other hardware to install the tape drive, mount them on the tape drive in this step.

If your system does not require special mounting hardware, proceed to step 5.

Step 5 — Installing the Drive

Slide the tape drive into the open bay, aligning the tray or rails with the slots in the bay, as shown in Figure 7.

Figure 7. Install the Drive

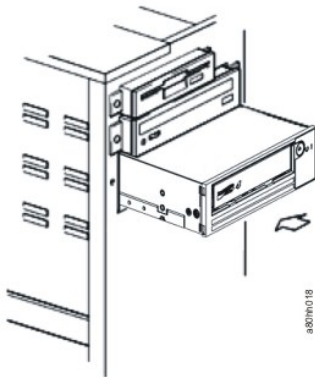

If your system does not use mounting hardware, check that the holes in the chassis are aligned with the holes in the side of the tape drive (see Figure 8).

Figure 8. Mounting Holes on Tape Drive

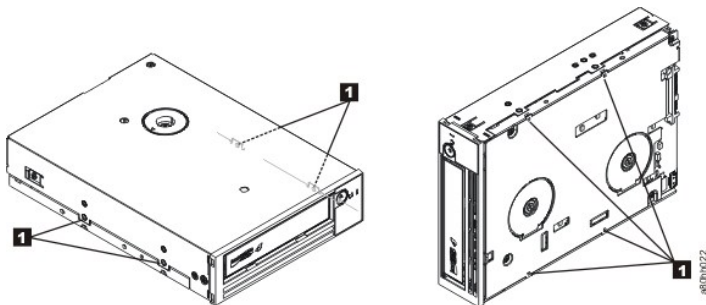

1. M-3 mounting screw holes

Do not secure the drive with screws at this point because you may have to move the drive to get the cables in place.

Step 6 — Attaching SAS Cable

Attach the system SAS cable to the drive SAS connector, as shown in [Figure 9](#), number 1.

 NOTE: You do not need to connect a separate power cable. Power is supplied through the SAS cable.

Figure 9. Attach SAS Cable



1. SAS cable

Step 7 — Securing the Drive

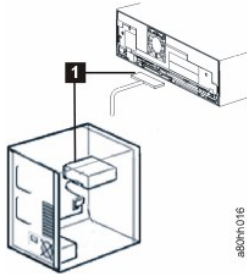
The tape drive can now be secured to the system as shown in [Figure 10](#). There are several ways to secure the drive. If the drive is on rails or in a sled, then push it in place. Some systems require the drive to be inserted into a media bay and attached directly to the system with screws.

Figure 10. Secure the Drive

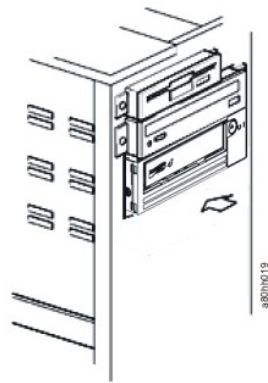

Step 8 — Connecting Host System Power and Testing Power to the Tape Drive

Connect the power cord to the system and to the electrical outlet. To ensure that the drive is receiving power, watch for the following indicators while turning on the power to the system:

1. The single-character display presents a series of random characters.
2. The single-character display becomes blank (not lit).
3. The Fault LED briefly turns on, then the ready/activity LED turns on solid.

Installing External Drives

Installing the Drive — Prerequisites

The SAS tape drive has a burst transfer rate of 300 MB per second. It is recommended that a dedicated host bus adapter is used for the tape drive.

Your system must have a properly installed and configured SAS host adapter or a SAS controller on the motherboard (if available) with driver software that supports the tape drive. Do not connect to a RAID controller channel; RAID controller channels are for disk drives only.

Installing the Drive — Step-By-Step Instructions

Step 1 — Positioning the Tape Drive

Position the tape drive convenient to the system. The only restrictions are the length of the power cord and the length of the SAS cable. The following locations are

recommended:

- 1 Away from high-traffic areas, especially if the floor is carpeted.
- 1 Out of copy rooms to avoid toner and paper dust. Do not store paper supplies next to any unit.
- 1 Away from moving air, such as doorways, open windows, fans, and air conditioners.
- 1 Off the floor.
- 1 In a horizontal position.
- 1 Where the tape cartridge can easily be inserted.

⚠ **NOTICE:** The tape drive should not be stacked. Do not place anything on top of the unit.

Step 2 — Connecting Power

An external Dell PowerVault LTO4-120HH Tape Drive will operate using any voltage in the range 100–240 volts (50–60 Hz). No adjustment is needed. To connect your drive to the power supply, proceed as follows:

1. Plug the power cable securely into the socket on the rear panel of the drive. (See number 1 in [Figure 5](#).)
2. Plug the other end of the power cable into a grounded power outlet.
3. Power on the tape drive by pressing the power on/off button (see number 1 in [Figure 12](#).) The tape drive runs the POST, which checks all hardware except the drive head.

Step 3 — Connecting the SAS Cable

Attach one end of the SAS cable to the SAS host adapter card installed in the system. Attach the other end of the SAS cable to the SAS connector on the rear panel of the tape drive (see number 2 in [Figure 5](#)). The cable can be up to 5 m (16.4 ft) long. This configuration is shown in [Figure 11](#).

Figure 11. Connecting One SAS Device

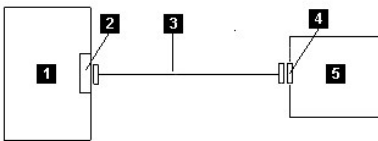

1. System
2. SAS host adapter card
3. SAS cable
4. Drive SAS connector
5. Tape drive

Step 4 — Configuring the Tape Drive to the Host

Power on the tape drive. Refer to your system and application software manuals to configure the tape drive for use.

Loading Device Drivers

Microsoft Windows 2003

This section describes how to install the Microsoft Windows 2003 Device Drivers for the tape drive.

⚠ **NOTICE:** Some backup software applications do not require device drivers to be loaded and, in some cases, installing device drivers could interfere with proper functioning of the application. See the documentation for the respective application prior to loading these drivers.

Installation Procedures

1. Ensure that you are logged on to the host server or workstation with Administrator privileges.
2. Insert the *Dell PowerVault LTO4-120HH Documentation and Drivers* CD into the CD drive on the host system.
3. Right-click the **My Computer** icon on the Windows desktop, click **Manage**, and then click **Device Manager**.

The tape drive should be listed under the ? **Other Devices** item as **IBM Ultrium-HH4 SCSI Sequential Device**.

4. Right-click the **IBM Ultrium-HH4 SCSI Sequential Device** listing, click **Uninstall**, and then click **OK** to confirm that you want to remove the device.
5. Right-click the topmost item in the menu structure in the right half of the **Computer Management** window.

A pop-up window appears.

6. Click **Scan for Hardware Changes**.

Windows 2003 scans for the Dell PowerVault LTO4-120HH drive. (If a wizard pops up at this point, cancel the wizard. It will be used later.) The tape drive appears under ? **Other Devices** again. If the tape drive is not visible, you may have to click the plus sign ("+") in front of ? **Other Devices** to make it appear.

7. Right-click the **IBM Ultrium-HH4 SCSI Sequential Device** listing and click **Properties**.
 8. Click the **Reinstall Driver** button. (If the **Reinstall Driver** button is not visible, you may have to click the **Driver** tab, then **Update driver**.)
 9. The Upgrade Device Driver Wizard appears.
 10. Click the **Install from List or Specific Location** radio button.
 11. Click **Next**.
 12. Click **Include this location in the search**.
 13. Type the driver name in the directory field, replacing d: with the drive letter for the CD drive into which you inserted the support CD and click the **Next** button.
Driver names are as follows:
 - o Windows 2003 32 bit: **d:\Drivers\Windows 2003 32bit x86\dtapeW32.inf**
 - o Windows 2003 x64: **d:\Drivers\Windows 2003 x64\dtapex64.inf**
 14. You may have to click **Continue** to bypass a warning.
 15. Click **Finish**.
 16. Close the **Device Properties** dialog box.
 17. The drive now appears in **Device Manager** under **Tape Drives** and is ready to use.
-

Verifying Drive Operation

After you install the drive hardware, verify that it is functioning properly before you store your valuable data. Turn on the system. For external drives, turn on the drive before you turn on the system.

The tape drive will run its POST, which checks all hardware except for the drive head. The single-character display will present a series of random characters, and then become blank (not lit). The fault LED will flash once, then the Ready/Activity LED will turn on solid.

Verify that the tape drive installation was successful. Following the instructions given with your Tape Backup Software application, write test data to a tape, read the test data from the tape, and compare the data read from the tape with the original data on disk.

[Back to Contents Page](#)

[Back to Contents Page](#)

Using the Tape Backup Software: Dell™ PowerVault™ LTO4-120HH Tape Drive User's Guide

See the *User's Operating Guide* supplied with your Tape Backup application for more information about using the Tape Backup software. For the latest supported software versions, go to the Dell support website at support.dell.com or visit the support site of your backup software vendor.

[Back to Contents Page](#)

[Back to Contents Page](#)

Specifications: Dell™ PowerVault™ LTO4-120HH Tape Drive User's Guide

- [General](#)
- [External Drive](#)
- [Internal Drive](#)

 NOTE: These specifications are provided by the manufacturer for information purposes only and do not constitute an extension of Dell's warranty to you. Dell's warranty is contained in the documentation for your system.

General	
Manufacturer	Manufactured for Dell
Model Number (Internal & External Drives)	DELL PowerVault LTO4-120HH Tape Drive
Interface Type	3Gb SAS interface

External Drive	
Physical Specifications	
Width	25.9 cm (10.2 in)
Length	27.7 cm (10.91 in)
Height	6.3 cm (2.48 in)
Weight	4.17 kg (9.2 lb)
Power Requirements	
AC line voltage	100–240 VAC
Line frequency	50–60 Hz, auto-ranging
Line current at 100 VAC	0.58 A
Line current at 240 VAC	0.24 A
Performance	
Interface	3Gb SAS
Recording format	LTO Ultrium Generation 4
Media	LTO Ultrium
Capacity	800 GB (native) 1600 GB (compressed, assuming 2:1 compression)
Data transfer rate (maximum)	120 MB/sec Native
Burst transfer rate	up to 300 MB/sec
Operating Limits	
Temperature	10° to 40°C (50° to 95°F)
Humidity	20% to 80% relative humidity (noncondensing)
Maximum wet bulb temperature	23°C (73.4°F)
Maximum altitude	3048 m (10,000 ft)
Nonoperating Limits (Storage or Shipping)	
Temperature	-40° to 65°C (-40° to 149°F)
Humidity	5% to 95% relative humidity (noncondensing)

Maximum wet bulb temperature	23°C (73.4°F)
------------------------------	---------------

Internal Drive

Physical Specifications

Width (without bezel)	146.0 mm (5.75 in)
Width (with bezel)	148.0 mm (5.83 in)
Length (without bezel)	205.0 mm (8.09 in)
Length (with bezel)	210.0 mm (8.29 in)
Height (without bezel)	41.0 mm (1.63 in) without bezel
Height (with bezel)	42.7 mm (1.69 in) with bezel
Weight (without a cartridge)	1.5 kg (3 lb 5 oz)

Power Supply Requirements

Tolerance	+ 5 VDC and + 12 VDC (plus or minus 10%)
Steady State Current for 5 VDC	2 A minimum/3.6 A maximum
Steady State Current for 12 VDC	0.2 A minimum/0.9 A maximum
Peak supply current for 5 VDC	3.6 A for 100 ms (18 W)
Peak supply current for 12 VDC	4.1 A for 2 ms (49.2 W)

Power Usage

Idle mode with no cartridge	12 W
Idle mode with a cartridge loaded	13 W
Reading and writing at 6.22 m/s	25 W

Performance

Interfaces	3Gb SAS
Recording format	LTO Ultrium Generation 4
Media	LTO Ultrium
Capacity	800 GB (native) 1600 GB (compressed, assuming 2:1 compression)
Data transfer rate (maximum)	120 MB/sec Native
Burst transfer rate	up to 300 MB/sec for SAS

Operating Limits

Temperature	10° to 40°C (50° to 95°F)
Humidity	20% to 80% relative humidity (non-condensing)
Maximum wet bulb temperature	23°C (73.4°F)
Maximum altitude	3048 m (10,000 ft)

Non-operating Limits (Storage)

Temperature	-40° to 65° (-40° to 149°F)
Humidity	5% to 95% relative humidity (noncondensing)
Maximum wet bulb temperature	23°C (73.4°F)

Troubleshooting: Dell™ PowerVault™ LTO4-120HH Tape Drive User's Guide

- [Obtaining Drivers and Firmware Upgrades](#)
- [Selecting a Diagnostic or Maintenance Function](#)
- [General Guidelines](#)
- [Methods of Receiving Errors and Messages](#)
- [Descriptions and Corrective Actions](#)
- [Fixing SAS Connectivity Problems](#)
- [Resolving Media-Related Problems](#)
- [Removing an Internal SAS Drive](#)
- [TapeAlert](#)
- [Recovering a Tape Cartridge](#)

Obtaining Drivers and Firmware Upgrades

- ➔ NOTICE: When updating firmware, do not power off the tape drive until the update is complete, or the firmware may be lost.

For information on the latest versions of firmware, see the Dell support website at support.dell.com.

Selecting a Diagnostic or Maintenance Function

The tape drive can run diagnostics, test write and read functions, test a suspect tape cartridge, and perform other diagnostic and maintenance functions. The drive must be in maintenance mode to perform these functions. To place the drive in maintenance mode and select a diagnostic or maintenance function, see [Table 3](#).

- ✎ NOTE: The host interface on this tape drive is Serial Attached SCSI (SAS). This interface presents SCSI protocol to the tape drive. In this User's Guide, references to SCSI relate to SCSI protocol, not the serial interface that it is transmitted over.
- ✎ NOTE: You cannot perform maintenance functions concurrently with read or write operations. While in maintenance mode, the tape drive does not accept SCSI commands from the system. Close all tape drive applications before entering maintenance mode.

Table 3. Diagnostic and Maintenance Function Codes and Descriptions

Function Code 1 — Run Tape Drive Diagnostics
Causes the tape drive to run self tests.
Attention: Insert only a scratch data cartridge for this test. Data on the cartridge will be overwritten.
<ol style="list-style-type: none">1. Ensure that there is no cartridge in the drive.2. Press the eject button three times within an interval of 2 seconds. The fault LED becomes solid amber, which means that the drive is in maintenance mode.3. Press the eject button once per second until f appears in the single-character display. If you cycle past f, continue to press the eject button until it reappears.4. To select the function, press and hold the eject button for 3 seconds. After you select the function, f flashes, the drive runs diagnostics for approximately 90 seconds, then e flashes. When e flashes, the drive is waiting for a cartridge.5. Within 60 seconds, insert a scratch data cartridge that is not write-protected.<ul style="list-style-type: none">✎ NOTE: If you wait longer than 60 seconds to load a cartridge, the drive automatically exits maintenance mode. If you insert a write-protected cartridge, the tape drive displays a e and retains the cartridge until it is manually ejected. When the cartridge is ejected and removed, the tape drive exits maintenance mode.
After you insert the cartridge, f flashes and the test begins.
<ul style="list-style-type: none">○ The diagnostic test takes approximately 5 minutes to run. The tape drive will unload and load the cartridge during the test. Do not try to remove the cartridge when it unloads the first time. Wait for the test to complete.○ If the diagnostic completes successfully, the cartridge ejects, the single-character display flashes a e, then goes blank, and the drive exits maintenance

mode.

- o If the diagnostic fails, the fault LED flashes and an error code displays. When the cartridge is manually ejected and removed, the tape drive automatically exits maintenance mode.
- o To halt the diagnostic and terminate the test, press the eject button twice anytime during the test. The drive acknowledges the request by slowing the flash rate of the **E** on the single-character display from twice per second to once per second. The tape drive rewinds and unloads the cartridge and then exits maintenance mode.

Function Code 2 — RESERVED (Service Function)

Function Code 3 — RESERVED (Service Function)

Function Code 4 — Force a Dump of Vital Data to Tape Drive Memory

Causes the tape drive to perform a collection (or *dump*) of vital technical data and save it to drive memory. (A drive dump is also known as a save of the firmware trace.)

➔ **NOTICE:** When an error code is displayed in maintenance mode, the tape drive also displays a red dot to remind you that a dump already exists. If you perform Function Code 4, it will overwrite the dump and cause the error information to be lost.

1. Ensure that there is no cartridge in the drive.
2. Press the eject button three times within an interval of 2 seconds. The fault LED becomes solid amber, which means that the drive is in maintenance mode.
3. Press the eject button once per second until **E** appears in the single-character display. If you cycle past **E**, continue to press the eject button until it reappears.
4. To select the function, press and hold the eject button for 3 seconds. After you select the function, **E** displays, followed by **D**. The single-character display then goes blank, and the tape drive exits maintenance mode.

You can also perform this operation when the tape drive is in normal operating mode. Simply press and hold the eject button for 10 seconds.

Function Code 5 — RESERVED (Service Function)

Function Code 6 — RESERVED (Service Function)

Function Code 7 — RESERVED (Service Function)

Function Code 8 — RESERVED (Service Function)

Function Code 9 — Display Error Code Log

Causes the tape drive to display the last ten error codes, one at a time. (The codes are ordered; the most recent is presented first and the oldest (tenth) is presented last.)

To view the drive error log:

1. Ensure that there is no cartridge in the drive.
2. Within a 2 second interval press the eject button three times. The fault LED becomes solid amber, which means that the drive is in maintenance mode.
3. Press the eject button once per second until **E** appears in the single-character display.
4. Press and hold the eject button for 3 seconds to view the most recent error code.
5. Refer to "[Descriptions and Corrective Actions](#)." to determine the meaning of the code and the action to take.
6. Press the eject button to view the next error code. (The codes are ordered; the most recent is presented first and the oldest (tenth) is presented last.)
7. Continue to press the eject button until **D** appears, indicating that no more error codes exist. If no errors have been encountered or the log has just been cleared, a **D** will appear immediately and the drive will exit maintenance mode. A maximum of ten error codes are stored.

To redisplay the error codes, repeat steps 1 through 7.

Function Code A — Clear Error Code Log

Causes the tape drive to erase the contents of the error code log.

1. Ensure that there is no cartridge in the drive.
2. Press the eject button three times within an interval of 2 seconds. The fault LED becomes solid amber, which means that the drive is in maintenance mode.
3. Press the eject button once per second until **E** appears in the single-character display. If you cycle past **E**, continue to press the eject button until it reappears.
4. To select the function, press and hold the eject button for 3 seconds. After you select the function, the tape drive erases all errors from the error code log, displays **D**, then exits maintenance mode.

Function Code C — Insert Cartridge Into Tape Drive

This function cannot be selected by itself. It relates to other maintenance functions (such as Run Tape Drive Diagnostics) that require a scratch tape cartridge that is not write protected.

Function Code E — Test Cartridge & Media

Causes the tape drive to perform a Write/Read test (on the edge bands) to ensure that a suspect cartridge and its magnetic tape are acceptable. The tape drive takes approximately 15 minutes to run one loop of the test. The test loops ten times before completing.

- 1 If no error is detected, the test begins again and runs for a maximum of ten times. After the tenth loop, the test stops and the drive automatically exits maintenance mode.
- 1 If an error is detected, the tape drive displays "6" or "7" in the single-character display. Once the cartridge is manually ejected and removed, the tape drive exits maintenance mode.
- 1 To halt the diagnostic at the end of the current 15 minute test loop, press the eject button once. The drive acknowledges the request by slowing the length of time that the currently displayed character flashes on the single-character display (from twice per second to once per second). The diagnostic continues to the end of its loop and then stops. The tape drive then rewinds, unloads the cartridge, and exits maintenance mode.
- 1 To halt the diagnostic immediately and terminate the test that is running, press the eject button twice. The tape drive rewinds, unloads the cartridge, and exits maintenance mode.

Attention: Data on the suspect tape will be overwritten.

1. Ensure that there is no cartridge in the drive.
2. Press the eject button three times within an interval of 2 seconds. The fault LED becomes solid amber, which means that the drive is in maintenance mode.
3. Press the eject button once per second until **E** appears in the single-character display. If you cycle past **E**, continue to press the eject button until it reappears.
4. To select the function, press and hold the eject button for 3 seconds. After you select the function, **C** flashes. When **C** flashes, the drive is waiting for a cartridge. Within 60 seconds, insert the suspect data cartridge (or the tape drive exits maintenance mode). After you insert the cartridge, **E** flashes and the test begins:
 - o If no error is detected, the test begins again and runs for a maximum of ten times. After the tenth loop, the test stops and the drive automatically exits maintenance mode. To halt the test, press the eject button. The tape drive then rewinds and unloads the cartridge, displays **D**, and exits maintenance mode.
 - o If an error is detected, the tape drive displays **S** or **T**. Once the cartridge is manually ejected and removed, the tape drive exits maintenance mode.

Function Code F — Write Performance Test

Causes the tape drive to perform tests to ensure that the drive can read from and write to tape. This diagnostic performs fewer tests than the Run Tape Drive Diagnostics test (Function Code 1). The tape drive takes approximately 3 minutes to run the test. The Fast Read/Write Test is not as comprehensive a test and is not recommended for isolating errors between the drive and the media.

Attention: Data on the suspect tape will be overwritten.

1. Ensure that there is no cartridge in the drive.
2. Press the eject button three times within an interval of 2 seconds. The fault LED becomes solid amber, which means that the drive is in maintenance mode.
3. Press the eject button once per second until **F** appears in the single-character display. If you cycle past **F**, continue to press the eject button until it reappears.
4. To select the function, press and hold the eject button for 3 seconds. After you select the function, **C** flashes. When **C** flashes, the drive is waiting for a cartridge. Within 60 seconds, insert the suspect data cartridge (or the tape drive exits maintenance mode). After you insert the cartridge, **F** flashes and the test begins:
 - o If no error is detected, the test begins again and runs for a maximum of ten times. Each loop takes approximately 3 minutes to run. After the tenth loop, the test stops and the drive automatically exits maintenance mode.
 - o If an error is detected, the tape drive displays an error code. Once the cartridge is manually ejected and removed, the tape drive exits maintenance mode.
 - o To halt the diagnostic at the end of the current 3 minute test loop, press the eject button once. The drive acknowledges the request by slowing the length of time that the currently displayed character flashes on the single-character display (from twice per second to once per second.) The diagnostic continues to the end of its loop and then stops. The tape drive then rewinds, unloads the cartridge, and exits maintenance mode.
 - o To halt the diagnostic immediately and terminate the test that is running, press the eject button twice. The tape drive rewinds, unloads the cartridge, and exits maintenance mode.

Function Code H — Test Head

Causes the tape drive to perform the Head Resistance Measurements test and a Write/Read test (on the center of the tape). The drive runs these tests to ensure that the tape drive's head and tape-carriage mechanics are working correctly. The tape drive takes approximately 10 minutes to run the test.

1. Ensure that there is no cartridge in the drive.
2. Press the eject button three times within an interval of 2 seconds. The fault LED becomes solid amber, which means that the drive is in maintenance mode.
3. Press the eject button once per second until **H** appears in the single-character display. If you cycle past **H**, continue to press the eject button until it reappears.
4. To select the function, press and hold the eject button for 3 seconds. After you select the function, **C** flashes. When **C** flashes, the drive is waiting for a cartridge. Within 60 seconds, insert a scratch data cartridge (or the tape drive exits maintenance mode). After you insert the cartridge, **H** flashes and the test begins:
 - o If no error is detected, the test begins again and runs for a maximum of ten times. Each loop takes approximately 10 minutes to run. After the tenth loop, the test stops and the drive automatically exits maintenance mode.
 - o If an error is detected, the tape drive displays "5", unloads the tape cartridge, and exits maintenance mode.
 - o To halt the diagnostic at the end of the current 10 minute test loop, press the eject button once. The drive acknowledges the request by slowing the length of time that the currently displayed character flashes on the single-character display (from twice per second to once per second.) The diagnostic continues to the end of its loop and then stops. The tape drive then rewinds, unloads the cartridge, and exits maintenance mode.
 - o To halt the diagnostic immediately and terminate the test that is running, press the eject button twice. The tape drive then rewinds, unloads the cartridge,

and exits maintenance mode.

Function Code J - Fast Read/Write Test

Approximate Run Time = 5 minutes

Total Number of Loops = 10

Function Code J performs tests to ensure that the drive can read from and write to tape.

The diagnostic loops ten times. Press the eject button to stop the diagnostic and exit maintenance mode. Pressing the eject button once will abort the test at the end of the current test loop. Pressing the eject button twice will abort the test immediately.

Attention: For this test, insert only a scratch (blank) data cartridge or a cartridge that may be overwritten. During the test, the drive overwrites the data on the cartridge.

1. Ensure that there is no cartridge in the drive.
2. Press the eject button three times within an interval of 2 seconds. The fault LED becomes solid amber, which means that the drive is in maintenance mode.
3. Press the eject button once per second until J appears in the single-character display. If you cycle past J, continue to press the eject button until it reappears.
4. Press and hold the eject button for three or more seconds, then release it to select the function. The single-character display changes to a flashing J.
5. Within 60 seconds, insert a scratch data cartridge that is not write-protected.

 **NOTE:** If you wait longer than 60 seconds to load a cartridge, the drive will automatically exit maintenance mode. If you insert a write-protected cartridge, the tape drive will display a P and retain the cartridge until it is manually ejected. Once the cartridge is ejected and removed, the tape drive will exit maintenance mode.

After you insert the cartridge, the single-character display changes to a flashing J, and the tape drive runs the tests.

Note: If you inserted an invalid cartridge, error code 7 appears in the single-character display. The tape drive retains the cartridge until it is manually ejected. Once ejected, the tape drive exits maintenance mode.

- o If no error is detected, the test will loop and begin again. To stop the loop, press the eject button for one second and release. When the loop ends, the drive rewinds, unloads the tape, and exits maintenance mode.
- o If an error is detected, the fault LED flashes amber, the tape drive posts an error code to the single-character display. To determine the error, locate the code in "[Descriptions and Corrective Actions](#)". Once the cartridge is manually ejected and removed, the tape drive exits maintenance mode.

Function Code L — Load/Unload Test

Approximate Run Time = 15 seconds per loop

Total Number of Loops = 10

Function Code L tests the drive's ability to load and unload a tape cartridge.

The diagnostic loops ten times. To stop the diagnostic and exit maintenance mode, press the eject button once to abort the test.

Attention: Even though no data is written during this test, it is recommended that you use a blank (scratch) cartridge for this test.

1. Ensure that there is no cartridge in the drive.
2. Press the eject button three times within an interval of 2 seconds. The fault LED becomes solid amber, which means that the drive is in maintenance mode.
3. Press the eject button once per second until L appears in the single-character display. If you cycle past L, continue to press the eject button until it reappears.
4. Press and hold the eject button for three or more seconds, then release it to select the function. The single-character display changes to a flashing L.
5. Within 60 seconds, insert a scratch data cartridge that is not write-protected.

 **NOTE:** If you wait longer than 60 seconds to load a cartridge, the drive will automatically exit maintenance mode. If you insert a write-protected cartridge, the tape drive will display a P and retain the cartridge until it is manually ejected. Once the cartridge is ejected and removed, the tape drive will exit maintenance mode.

After you insert the cartridge, the single-character display changes to a flashing L. The tape drive runs the tests.

- o If no error is detected, the test will loop and begin again. To stop the loop, press the eject button for one second and release. When the loop ends, temporarily appears in the single-character display. The drive rewinds the tape and unloads the cartridge. The drive then exits maintenance mode.
- o If an error is detected the test stops, 7 appears in the single-character display. To determine the error, locate 7 in "[Descriptions and Corrective Actions](#)". The drive unloads the tape cartridge and exits maintenance mode. To clear the error, turn the tape drive power off, then on again.

Function Code P or U — RESERVED (Service Function)

General Guidelines

If you encounter problems when running the Dell PowerVault LTO4-120HH Tape Drive, refer to Table 4 for common problems. If the problem is not identified, refer to "[Methods of Receiving Errors and Messages](#)." The color and condition of the LEDs may also indicate a problem.

Table 4. General Troubleshooting

If the problem is this...	Do this...
A code displays on the single-character display and the fault LED flashes amber.	The tape drive detected an error or is directing you to an informational message. See " Methods of Receiving Errors and Messages ."
The ready/activity LED or single-character display never turns on.	The tape drive has no power. Check the power at the power source. Connect power to the tape drive. If the problem persists, contact Dell technical support.
The tape drive does not load a tape cartridge.	One of the following has occurred: <ol style="list-style-type: none"> 1 A tape cartridge is already loaded. To remove the cartridge, press the eject button. If the cartridge does not eject, turn off the power to the tape drive, then turn it back on. After the ready/activity LED becomes solid green, press the eject button to eject the cartridge. 1 The cartridge tray may not be in the correct position. Press the eject button to return the tray to the correct position. 1 The tape cartridge was loaded incorrectly. To properly load a cartridge, see the Loading section in "Loading, Unloading, and Write-Protecting Cartridges." 1 The tape cartridge may be defective. Load another tape cartridge. If the problem exists for multiple cartridges, the tape drive is defective. Contact Dell technical support. 1 The tape drive has no power. Connect power to the tape drive.
The tape drive does not unload the tape cartridge.	The tape cartridge is stuck or is broken. Press the eject button. If the cartridge does not eject, turn off the power to the tape drive, and then turn it back on. (Note that the mid-tape recovery could take up to 10 minutes to complete.) If the cartridge still does not eject, manually remove it (see " Recovering a Tape Cartridge ").
The system received TapeAlert flags.	See " TapeAlert Flags ."
The system reported system problems (such as selection or command time-outs, or parity errors).	See " Fixing SAS Connectivity Problems ."
Codes display on the single-character display, but the ready/activity LED does not turn on.	The tape drive is defective. Contact Dell technical support.
The tape drive does not respond to system commands.	Press and hold the eject button on the drive for 10 seconds to force a drive dump. The drive will save the dump and then reboot to allow communication to the drive to occur. Do not cycle power, as this will erase the contents of the dump.

Methods of Receiving Errors and Messages

Use [Table 5](#) as a guide for identifying error codes and message codes reported by the tape drive, its computer (if applicable), or the system.

 NOTE: The codes on the single-character display have different meanings, depending on whether they display during normal operations or while the drive is in maintenance mode. Codes that occur during normal operations are defined in "[Descriptions and Corrective Actions](#)." Codes that occur while in maintenance mode are defined in "[Selecting a Diagnostic or Maintenance Function](#)."

Table 5. Methods of Receiving Errors and Messages

If the error or message was presented by...	Do this...
The system's display (if the tape drive is enclosed in a library or autoloader)	Refer to the documentation for the system.
The tape drive's single-character display and the fault LED flashes amber	See " Descriptions and Corrective Actions ." To determine the meaning of the LED, see the " Front Panel " section in the Introduction.
The tape drive's single-character display and the fault LED is solid amber	See " Selecting a Diagnostic or Maintenance Function ." To determine the meaning of the fault LED activity, see the " Front Panel " section in the Introduction.
SCSI log sense data (such as TapeAlert flags) or SCSI drive sense data	See " TapeAlert Flags " or " Descriptions and Corrective Actions ."
The tape drive's error log	See " Descriptions and Corrective Actions ."

Descriptions and Corrective Actions

Table 6 gives descriptions of the errors and messages that pertain to the tape drive, and tells what to do when you receive them.









NOTICE: If the tape drive detects a permanent error and displays an error code other than , it automatically performs a dump of vital data to drive memory. If you force a dump, the existing dump will be overwritten and data will be lost. After you force a dump, do not turn off the power to the tape drive or you may lose the dump data.

Table 6. Descriptions and Corrective Actions

The single-character display clears if you power-off the drive.	
Code	Cause and Action
	<p>No error occurred and no action is required. This code displays:</p> <ul style="list-style-type: none"> 1 When power is cycled (turned off, then on) to the tape drive 1 When diagnostics have finished running and no error occurred <p>NOTE: The single-character display is blank during normal operation of the tape drive.</p>
	<p>Cooling problem. The tape drive detected that the recommended operating temperature was exceeded. Perform the following action:</p> <ul style="list-style-type: none"> 1. If a fan is present in the system, ensure that it is rotating and is quiet. If not, replace the fan. (For instructions about replacing the fan, see your system's documentation.) 2. Remove any blockage that prevents air from flowing freely through the tape drive. 3. Ensure that the operating temperature and airflow is within the specified range (see "Specifications"). 4. If the operating temperature is within the specified range and the problem persists, contact Dell technical support. <p>The error code clears when you power-off the tape drive or place it in maintenance mode.</p>
	<p>Power problem. The tape drive detected that the externally supplied power is either approaching the specified voltage limits (the drive is still operating) or is outside the specified voltage limits (the drive is not operating). Perform the following action:</p> <ul style="list-style-type: none"> 1. Ensure that the power connector is properly seated. 2. Ensure that the proper DC voltages are being applied within the tolerances allowed (see "Specifications"). 3. If the proper voltages are being applied but the problem persists, contact Dell technical support. <p>The error code clears when you power-off the tape drive or place it in maintenance mode.</p>
	<p>Firmware problem. The tape drive determined that a firmware error occurred. Perform the following action:</p> <ul style="list-style-type: none"> 1. Power the tape drive off and on, then retry the operation that produced the error. The error code clears when you power-off the tape drive or place it in maintenance mode. 2. If the problem persists, download the latest firmware and retry the operation.
	<p>Firmware or tape drive problem. The tape drive determined that a firmware or tape drive hardware failure occurred. Perform the following action:</p> <ul style="list-style-type: none"> 1. Power the tape drive off and on, then retry the operation that produced the error. The error code clears when you power-off the tape drive or place it in maintenance mode. 2. If the problem persists, download the latest firmware and retry the operation; if new firmware is not available, contact Dell technical support.
	<p>Tape drive hardware problem. The drive determined that a tape path or read/write error occurred. To prevent damage to the drive or tape, the drive will not allow you to insert a cartridge if the current cartridge was successfully ejected. The error code may clear when you cycle power to the tape drive or place it in maintenance mode. If the problem persists, contact Dell technical support.</p>
	<p>Tape drive or media error. The drive determined that an error occurred, but it cannot isolate the error to faulty hardware or to the tape cartridge. Perform the appropriate action, as described below:</p> <p>For Problems with Writing Data:</p> <p>If the problem occurred while the drive was writing data to the tape, and if you know the volume serial number (located on the cartridge label) of the tape cartridge loaded in the drive when the problem occurred, retry the operation with a different cartridge:</p> <ul style="list-style-type: none"> 1 If the operation succeeds, the original cartridge was defective. Copy data from the defective cartridge and discard it. 1 If the operation fails and another drive is available, insert the cartridge into the other drive and retry the operation. <ul style="list-style-type: none"> o If the operation fails, discard the defective cartridge. o If the operation succeeds, insert a scratch cartridge into the first drive and run the tape drive diagnostics (see Function Code 1 in "Selecting a Diagnostic or Maintenance Function"). <ul style="list-style-type: none"> n If the diagnostics fail, contact Dell technical support. n If the diagnostics succeed, the error was temporary. 1 If the operation fails and another drive is not available, insert a scratch cartridge into the drive and run the tape drive diagnostics (see Function Code 1 in "Selecting a Diagnostic or Maintenance Function"). <ul style="list-style-type: none"> o If the diagnostics fail, contact Dell technical support. o If the diagnostics succeed, discard the cartridge.

6	<p>If the problem occurs with multiple tape cartridges or if you do not know the tape cartridge's volume serial number, run the tape drive diagnostics (see Function Code 1 in "Selecting a Diagnostic or Maintenance Function"): </p> <ul style="list-style-type: none"> 1 If the diagnostics fail, contact Dell technical support. 1 If the diagnostics succeed, run the Test Head diagnostic (see Function Code H in "Selecting a Diagnostic or Maintenance Function "). <ul style="list-style-type: none"> o If the Test Head diagnostic fails, contact Dell technical support. o If the Test Head diagnostic succeeds, replace the cartridges that caused the problem. <p>The error code clears when you remove the tape cartridge or place the drive in maintenance mode.</p> <p>For Problems with Reading Data:</p> <p>If the problem occurred while the drive was reading data from the tape, and if you know the volume serial number of the tape cartridge, perform one of the following procedures:</p> <ul style="list-style-type: none"> 1 If another drive is available, insert the cartridge into the other drive and retry the operation: <ul style="list-style-type: none"> o If the operation fails, discard the defective cartridge. o If the operation succeeds, insert a scratch cartridge into the first drive and run the tape drive diagnostics (see Function Code 1 in "Selecting a Diagnostic or Maintenance Function"): <ul style="list-style-type: none"> n If the diagnostics fail, contact Dell technical support. n If the diagnostics succeed, the error was temporary. 1 If another drive is not available, insert a scratch cartridge into the drive and run the tape drive diagnostics (see Function Code 1 in "Selecting a Diagnostic or Maintenance Function"): <ul style="list-style-type: none"> o If the diagnostics fail, contact Dell technical support. o If the diagnostics succeed, discard the cartridge. <p>If the problem occurs with multiple tape cartridges or if you do not know the tape cartridge's volume serial number, run the tape drive diagnostics (see Function Code 1 in "Selecting a Diagnostic or Maintenance Function"): </p> <ul style="list-style-type: none"> 1 If the diagnostics fail, contact Dell technical support. 1 If the diagnostics succeed, run the Test Head diagnostic (see Function Code H in "Selecting a Diagnostic or Maintenance Function "). <ul style="list-style-type: none"> o If the Test Head diagnostic fails, contact Dell technical support. o If the Test Head diagnostic succeeds, replace the cartridges that caused the problem. <p>The error code clears when you remove the tape cartridge or place the drive in maintenance mode.</p>
7	<p>A high probability of media error. The tape drive determined that an error occurred because of a faulty tape cartridge. Try another tape cartridge. If the problem occurs with multiple tape cartridges, see "Resolving Media-Related Problems." This error will also appear if you are loading an expired cleaner cartridge.</p> <p>The error code clears when you remove the tape cartridge or place the drive in maintenance mode.</p>
8	<p>Tape drive or interface failure. The tape drive determined that a failure occurred in the tape drive's hardware or in the bus. See "Fixing SAS Connectivity Problems". The error code clears 10 seconds after the drive detected the error or when you place the drive in maintenance mode.</p>
9	<p>Library to drive interface (RS-422) error. This interface is not used in the PowerVault LTO4- 120HH tape drive.</p>
A	<p>Tape drive hardware problem. The tape drive determined that a problem occurred that degraded the operation of the tape drive, but it did not restrict continued use. If the problem persists, contact Dell technical support. The drive is usable, though the single-character display continues to indicate an error and the fault LED flashes amber.</p> <p>The error code may clear when you cycle power to the tape drive or place it in maintenance mode.</p>
b	<p>No error or message is assigned.</p>
c	<p>The tape drive needs to be cleaned. Clean the tape drive. See the "Cleaning the Tape Mechanism" section.</p> <p>The error code clears when you clean the tape drive or place it in maintenance mode.</p>
d	<p>No error or message is assigned.</p>
E	<p>Not applicable for a SAS drive.</p>
F	<p>Not applicable for a SAS drive.</p>
P	<p>Write protect. A write operation has been attempted to a write-protected cartridge or an overwrite has been attempted to a WORM cartridge. These operations are not allowed.</p>
p	<p>Encryption Error. The drive detected a configuration or set-up error prior to an encryption operation.</p>
s	<p>The eject button is depressed. Verify that the button pushes freely.</p>

Fixing SAS Connectivity Problems

If there appears to be a problem connecting or communicating with the drive, follow this procedure.

1. Ensure that the power is on to the tape drive.
2. Replace the SAS cable and interposers, if any, and retry the failing operation.
3. If these measures do not correct the problem, contact Dell customer support.

Resolving Media-Related Problems

To resolve problems that are related to media, the tape drive's firmware includes:

1. Test Cartridge & Media diagnostic that verifies whether a suspect cartridge and its magnetic tape are acceptable for use.
1. Statistical Analysis and Reporting System (SARS) to assist in isolating failures between media and hardware. To determine the cause of failure, SARS uses the cartridge performance history that is saved in the cartridge memory (CM) and the drive performance history that is kept in the drive's Vital Product Data (VPD) area in Non Volatile Random Access Memory (NVRAM). Any failures that SARS detects are reported as TapeAlert flags on the system (see "[TapeAlert Flags](#)").

If you encounter a media-related problem, use the following procedure:

➔ **NOTICE:** When you run the Test Cartridge & Media diagnostic, data on the suspect tape is overwritten. If valuable data is on the tape, be sure to copy the data before running this test.

1. If possible, run the tape cartridge in a different tape drive. If the operation in the other tape drive fails and **E** or **7** displays, replace the media. If the operation succeeds, run the Test Cartridge & Media diagnostic (see Function Code E in "[Selecting a Diagnostic or Maintenance Function](#)").
2. If the Test Cartridge & Media diagnostic fails, replace the media. If it runs successfully, clean the tape drive and run the tape drive diagnostics (see the "[Cleaning the Tape Mechanism](#)" section and Function Code 1 in "[Selecting a Diagnostic or Maintenance Function](#)").
3. If the tape drive diagnostics fail, contact Dell technical support. If the tape drive diagnostics run successfully, perform the operation that produced the initial media error.

Removing an Internal SAS Tape Drive

To remove an internal SAS tape drive from the system, perform the following steps:

1. Ensure that the tape drive does not contain a tape cartridge.
2. De-configure the drive from the system. (For instructions, see your system's documentation.)
3. Turn off the power to the system. Disconnect the power cable from the system and the electrical outlet.
4. Remove system cover.
5. Disconnect the internal SAS cable from the tape drive (see number 1 in [Figure 4. Rear Panel of Internal SAS Tape Drive](#)).
6. Remove the tape drive from the system and remove any mounting screws or rails from the side or bottom of the tape drive.
7. To reassemble, reverse these steps.

TapeAlert

TapeAlert is a patented technology and standard of the American National Standards Institute (ANSI) that defines conditions and problems that are experienced by tape drives. The technology enables a system to read TapeAlert flags from a tape drive through the SCSI interface. The system reads the flags from Log Sense Page 0x2E.

TapeAlert Flags

Table 7 lists the TapeAlert flags that are supported by the Dell PowerVault 110T LTO-3 Tape Drive.

Table 7. TapeAlert Flags and Descriptions

TapeAlert Flags Supported by the Tape Drive				
Flag Number	Flag Parameter (in hex)	Flag	Description	Action Required
3	03h	Hard error	Set for any unrecoverable read, write, or positioning error. (This flag is set in conjunction with flags 4, 5, or 6.)	See the Action Required column for Flag 4, 5, or 6 in this table.
4	04h	Media	Set for any unrecoverable read, write, or positioning error that is due to a faulty tape cartridge.	Contact Dell technical support.
5	05h	Read failure	Set for any unrecoverable read error where isolation is uncertain and failure could be due to a faulty tape cartridge or to faulty drive hardware.	If Flag 4 is also set, the cartridge is defective. Contact Dell technical support. If Flag 4 is not set, see error code 6 in " Descriptions and Corrective Actions ."

6	06h	Write failure	Set for any unrecoverable write or positioning error where isolation is uncertain and failure could be due to a faulty tape cartridge or to faulty drive hardware.	If Flag 9 is also set, make sure that the write-protect switch is set so that data can be written to the tape (see the " Setting the Write-Protect Switch " section.) If Flag 4 is also set, the cartridge is defective. Replace the tape cartridge. If Flag 4 is not set, see error code 6 in " Descriptions and Corrective Actions ."
8	08h	Not data grade	Set when severe servo errors occur while loading a tape cartridge.	Replace the tape cartridge. If this error occurs with multiple tapes, see error code 6 in " Descriptions and Corrective Actions ."
9	09h	Write protect	Set when the tape drive detects that the tape cartridge is write-protected.	Make sure that the cartridge's write-protect switch is set so that the tape drive can write data to the tape (see the " Setting the Write-Protect Switch " section).
10	0Ah	No removal	Set when the tape drive receives an UNLOAD command after the system prevented the tape cartridge from being removed.	Refer to the documentation for your system's operating system.
11	0Bh	Cleaning media	Set when you load a cleaning cartridge into the drive.	No action required.
12	0Ch	Unsupported format	Set when you load an unsupported cartridge type into the drive or when the cartridge format has been corrupted.	Use a supported tape cartridge.
15	0Fh	Cartridge memory chip failure	Set when a cartridge memory (CM) failure is detected on the loaded tape cartridge.	Replace the cartridge. If this error occurs on multiple tapes, see error code 6 in " Descriptions and Corrective Actions ."
16	10h	Forced eject	Set when you manually unload the tape cartridge while the drive was reading or writing.	No action required.
18	12h	Tape directory corrupted in the cartridge memory	Set when the drive detects that the tape directory in the cartridge memory has been corrupted.	Reread all data from the tape to rebuild the tape directory.
20	14h	Clean now	Set when the tape drive detects that it needs cleaning.	Clean the tape drive. See the " Cleaning the Tape Mechanism " section.
21	15h	Clean periodic	Set when the drive detects that it needs routine cleaning.	Clean the tape drive as soon as possible. The drive can continue to operate, but you should clean the drive soon. See the " Cleaning the Tape Mechanism " section.
22	16h	Expired clean	Set when the tape drive detects a cleaning cartridge that has expired.	Replace the cleaning cartridge.
23	17h	Invalid cleaning tape	Set when the drive expects a cleaning cartridge and the loaded cartridge is not a cleaning cartridge.	Use a valid cleaning cartridge.
30	1Eh	Hardware A	Set when a hardware failure occurs that requires that you reset the tape drive to recover.	If resetting the drive does not recover the error, use the error code from the single-character display, library user interface, or SCSI drive sense data. See " Descriptions and Corrective Actions ."
31	1Fh	Hardware B	Set when the tape drive fails its internal self tests.	Use the error code on the single-character display, library user interface, or SCSI drive sense data. See " Descriptions and Corrective Actions ."
32	20h	Interface	Set when the tape drive detects a problem with the SCSI or LDI (RS-422) interface.	Locate error code 8 or 9 in " Descriptions and Corrective Actions ."
33	21h	Eject media	Set when a failure occurs that requires you to unload the cartridge from the drive.	Unload and reload the tape cartridge.
34	22h	Download fail	Set when a field microcode replacement (FMR) image is unsuccessfully downloaded to the tape drive via the SAS interface.	Ensure that it is the correct image. Download the FMR image again.
36	24h	Drive temperature	Set when the drive's temperature sensor indicates that the drive's temperature is exceeding the recommended temperature of the system (see " Specifications ").	See error code 1 in " Descriptions and Corrective Actions ."
37	25h	Drive voltage	Set when the drive detects that the externally supplied voltages are either approaching the specified voltage limits or are outside the voltage limits (see " Specifications ").	See error code 2 in " Descriptions and Corrective Actions ."
39	27h	Diagnostics required	Set when the drive detects a failure that requires diagnostics to isolate the problem.	See error code 6 in " Descriptions and Corrective Actions ."

51	33h	Tape directory invalid at unload	Set when the tape directory on the tape cartridge that was previously unloaded is corrupted. The file-search performance is degraded.	Rebuild the tape directory by reading all the data.
52	34h	Tape system area write failure	Set when the tape cartridge that was previously unloaded could not write its system area successfully.	Copy the data to another tape cartridge, then discard the old cartridge.
53	35h	Tape system area read failure	Set when the tape system area could not be read successfully at load time.	Copy the data to another tape cartridge, then discard the old cartridge.

Recovering a Tape Cartridge

If problem-determination procedures identify the tape drive as the source of the problem and you are unable to eject the tape cartridge using the eject button, perform the following steps to reset the drive to recover the cartridge:

1. Press and hold the eject button for 10 seconds, then release.
 - o The fault LED turns on and the drive starts through its hardware test process.
 - o When the hardware test completes, the ready/activity LED turns on.
 - o If a cartridge is in the drive, the ready/activity LED flashes green until the cartridge is rewound.
 - o The ready/activity LED turns on solid when the rewind is complete and the tape drive is ready.

 NOTE: Allow at least 10 minutes for the rewind process to complete.

2. To eject the cartridge, push the eject button one more time. If the tape cartridge still will not eject, contact trained service personnel for assistance.

 NOTICE: If you are not a trained service person, do not attempt to open the drive for repairs as this will void your warranty.

[Back to Contents Page](#)

Using the Tape Drive: Dell™ PowerVault™ LTO4-120HH Tape Drive User's Guide

- [Operating the Drive](#)
- [Loading, Unloading and Write-Protecting Cartridges](#)
- [Caring for Tape Cartridges](#)
- [Cleaning the Tape Mechanism](#)

Operating the Drive

Turn on the external drive by pushing the power on/off button on the front panel (Figure 12). The tape drive runs its Power-On Self-Test (POST). At the end of the hardware self-test, the ready/activity LED must be solid green.

Figure 12. Turning on the External Drive

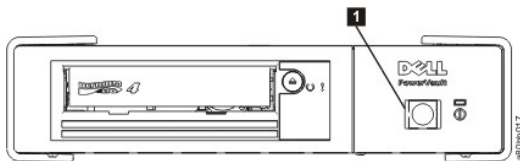

1. Power On/Off Button

Resetting the Drive

You can reset the drive without powering off the drive and system. This may be necessary if the drive stops responding. To do this, press and hold the eject button on the front panel of the tape drive for 10 seconds (Figure 13). The drive forces a dump of vital technical data to drive memory and overwrites the existing dump. The drive then reboots to allow communication.

Figure 13. Resetting the Drive



1. Eject Button

Loading, Unloading, and Write-Protecting Cartridges

Use only LTO Ultrium format cartridges with your drive, as specified in the LTO Ultrium standard. Ensure that only one label is stuck to the label area of the cartridge. Do not use nonstandard labels, and do not stick anything to the cartridge other than in the label area.

The tape drive uses the following cartridge types:

- 1 LTO Ultrium 200 GB Data Cartridge (Generation 2)
- 1 LTO Ultrium 400 GB Data Cartridge (Generation 3)
- 1 LTO Ultrium 800 GB Data Cartridge (Generation 4)
- 1 LTO Ultrium 400 GB WORM Data Cartridge (Generation 3)
- 1 LTO Ultrium 800 GB WORM Data Cartridge (Generation 4)
- 1 LTO Ultrium Universal Cleaning Cartridge

 **NOTE:** An LTO WORM cartridge can be written and appended but cannot be erased or overwritten.

The Dell PowerVault LTO4-120HH Tape Drive is compatible with the cartridges of its predecessors. Below is a description of the functions that are supported on the different compatible media types:

- 1 Generation 4 cartridges: Reads and writes Generation 4 format
- 1 Generation 3 cartridges: Reads and writes Generation 3 format
- 1 Generation 2 cartridges: Reads Generation 2 format
- 1 Does not write Generation 2 format on Generation 2 cartridges
- 1 Does not write Generation 4 format on Generation 3 cartridges
- 1 Does not reformat Generation 3 cartridges to Generation 4 format

Figure 14 shows the LTO Ultrium 800 GB Data Cartridge and its components.

Figure 14. LTO Ultrium 800 GB Data Cartridge

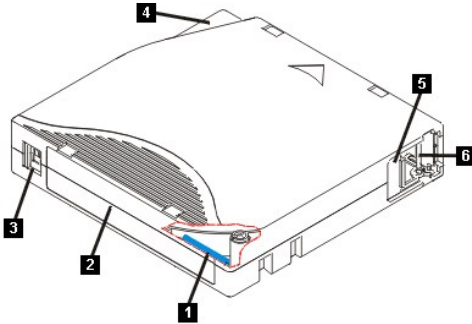

- 1. LTO cartridge memory
- 2. Label area
- 3. Write-protect switch
- 4. Insertion guide
- 5. Cartridge door
- 6. Leader pin

Loading a Tape Cartridge

- 1. Ensure that the tape drive is powered on. (The ready/activity LED is solid green.)
- 2. Ensure that the write-protect switch (see number 3 in Figure 14) is properly set. (See "Setting the Write-Protect Switch on Cartridges".)
- 3. Grasp the cartridge so that the write-protect switch faces you.
- 4. Slide the cartridge into the tape load compartment (see Figure 15). The tape drive automatically loads the cartridge.
 - o If the cartridge is already in the ejected position and you want to reinsert it, remove the cartridge and then insert it again.
 - o If the cartridge is already loaded and you cycle the power (turn it off, then on), the cartridge does not automatically eject. When the drive powers back on, the cartridge is brought back to the loaded position.

Figure 15. Loading

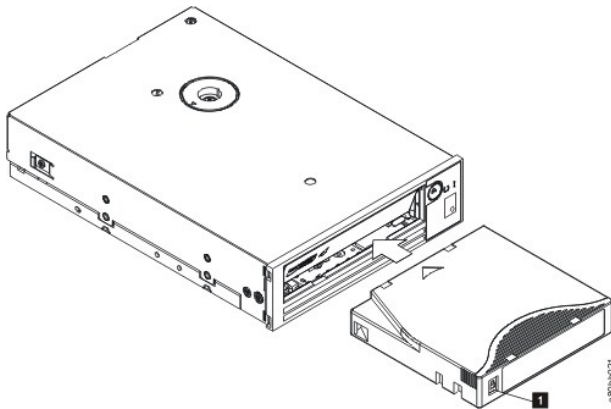

- 1. Write-Protect Switch

Unloading a Tape Cartridge

- 1. Ensure that the tape drive is powered on. (The ready/activity LED is solid green.)
- 2. Press the eject button (see number 1 in Figure 13). The drive rewinds the tape and ejects the cartridge. The ready/activity LED flashes green while the tape rewinds, then goes out before the cartridge ejects.
- 3. After the cartridge ejects, grasp the cartridge and remove it.

Whenever you unload a tape cartridge, the tape drive writes any pertinent information to the cartridge memory.

➡ NOTICE: Do not remove a tape cartridge while the drive activity indicator is on.

Setting the Write-Protect Switch on Tape Cartridges

➡ NOTICE: Write-protection will not prevent a cartridge from being erased by bulk-erasure or degaussing. Do not bulk-erase Ultrium format cartridges. This will destroy prerecorded servo information and render the cartridge unusable. Always use the long or quick erase command in your backup software to erase cartridges.

The position of the write-protect switch ([Figure 16](#)) on the tape cartridge determines whether you can write to the tape:

- 1 If the switch is set to locked (locked padlock), data cannot be written to the tape.
- 1 If the switch is set to unlocked (unlocked padlock or black void), data can be written to the tape.

Figure 16. Setting the Write-Protect Switch

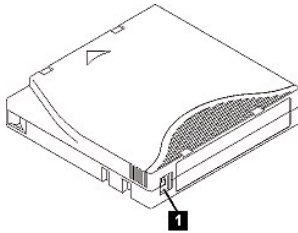

1. Write-Protect Switch

To set the switch, slide it left or right to the desired position.

➡ NOTICE: Always set the write protection tab prior to loading the cartridge into the drive. Sliding the tab after loading will cause unpredictable results and could result in drive errors or backup failure.

Caring for Tape Cartridges

➡ NOTICE: Do not insert a damaged tape cartridge into your tape drive. A damaged cartridge can interfere with the reliability of the drive and may void the warranties of the drive and the cartridge. Before inserting a tape cartridge, inspect the cartridge case, cartridge door, and write-protect switch for breaks.

Incorrect handling or an incorrect environment can damage the LTO Ultrium Tape Cartridge or its magnetic tape. To avoid damage to your tape cartridges and to ensure the continued high reliability of your tape drive, use the following guidelines.

Provide Training

- 1 Post procedures that describe proper media handling in places where people gather.
- 1 Ensure that anyone who handles tape has been properly trained in handling and shipping procedures. This includes operators, users, programmers, archival services, and shipping personnel.
- 1 Ensure that any service or contract personnel who perform archiving are properly trained in media-handling procedures.
- 1 Include media-handling procedures as part of any services contract.
- 1 Define and make personnel aware of data recovery procedures.

Ensure Proper Packaging

- 1 When you ship a cartridge, ship it in its original or similar packaging.
- 1 Always ship or store a cartridge in a jewel case.
- 1 Use only a recommended shipping container that securely holds the cartridge in its jewel case during transportation.
- 1 Never ship a cartridge in a commercial shipping envelope. Always place it in a box or package.
- 1 If you ship the cartridge in a cardboard box or a box of a sturdy material, ensure the following:
 - o Place the cartridge in polyethylene plastic wrap or bags to protect it from dust, moisture, and other contaminants.
 - o Pack the cartridge snugly; do not allow it to move around.
 - o Double-box the cartridge (place it inside a box, then place that box inside the shipping box) and add padding between the two boxes.

Provide Proper Acclimation and Environmental Conditions

- 1 Before you use a cartridge, let it acclimate to the normal operating environment for 1 hour. If you see condensation on the cartridge, wait an additional hour.
- 1 Ensure that all surfaces of a cartridge are dry before inserting it.
- 1 Do not expose the cartridge to moisture or direct sunlight.
- 1 Do not expose recorded or blank cartridges to stray magnetic fields of greater than 100 oersteds (for example, terminals, motors, video equipment, X-ray equipment, or fields that exist near high-current cables or power supplies). Such exposure can cause the loss of recorded data or make the blank cartridge unusable.
- 1 Maintain the following environmental conditions outlined in the [Table 2](#).

Table 2. Environmental Specifications

Environmental Factor	Operating	Operational Storage ¹	Archival Storage ²	Shipping
Temperature	10° to 45°C (50° to 113°F)	16° to 35°C (61° to 95°F)	16° to 25°C (61° to 77°F)	-23° to 49°C (-9° to 120°F)
Relative humidity (noncondensing)	10% to 80%	20% to 80%	20% to 50%	5% to 80%
Wet bulb temperature	26°C (79°F)	26°C (79°F)	26°C (79°F)	26°C (79°F)
Notes: 1. Operational storage equals less than 1 year. 2. Archival storage equals 1 to 10 years.				

Perform a Thorough Inspection

- 1. Inspect the cartridge's packaging to determine potential rough handling.
- 1. When inspecting a cartridge, open only the cartridge door. Do not open any other part of the cartridge case. The upper and lower parts of the case are held together with screws; separating them destroys the usefulness of the cartridge.
- 1. Inspect the cartridge for damage before using or storing it.
- 1. Inspect the rear of the cartridge (the part that you load first into the tape load compartment) and ensure that there are no gaps in the seam of the cartridge case. If there are gaps in the seam, the leader pin may be dislodged.
- 1. Check that the leader pin is properly seated.
- 1. If you suspect that the cartridge has been mishandled but it appears useable, copy any data onto a good cartridge immediately for possible data recovery. Discard the mishandled cartridge.
- 1. Review handling and shipping procedures.

Handle the Cartridge Carefully

- 1. Do not drop the cartridge. If the cartridge drops, slide the cartridge door back and ensure that the leader pin is properly seated in the pin-retaining spring clips.
- 1. Do not handle tape that is outside the cartridge. Handling the tape can damage the tape's surface or edges, which may interfere with read or write reliability. Pulling on tape that is outside the cartridge can damage the tape and the brake mechanism in the cartridge.
- 1. Do not stack more than six cartridges.
- 1. Do not degauss a cartridge that you intend to reuse. Degaussing makes the tape unusable.

Cleaning the Tape Mechanism

Dell PowerVault LTO4-120HH drives have been developed to have a minimal cleaning requirement. The tape drive will display a **C** on the single-character display and the fault LED will flash amber when the drive needs cleaning. Only insert a cleaning cartridge into the tape drive when the **C** is displayed.

ⓘ NOTICE: Only use LTO cleaning cartridges that are labeled "universal." The Generation 4 tape drive is only compatible with the LTO Ultrium universal cleaning cartridges. Use of any other type of cleaning cartridge or method can damage the read/write head in your drive. If you load any other type of cleaning cartridge, the tape drive displays a 7 in the SCD and retains the cartridge until it is ejected manually by pressing the Eject button.

An LTO Ultrium universal cleaning cartridge is supplied with each tape drive. Do *not* use swabs or other means of cleaning the heads. The cleaning cartridge uses a special tape to clean the tape heads.

Though the number may vary according to the manufacturer, the universal cleaning cartridge is generally valid for 50 separate cleaning operations. If you try to use the cleaning cartridge beyond 50 separate cleaning operations, an error code of 7 will be displayed. Eject the cleaning cartridge and replace it with a new one.

To use the LTO Ultrium universal cleaning cartridge:

- 1. Insert a cleaning cartridge into the tape drive. The tape drive performs the cleaning automatically. When the cleaning is finished, the drive ejects the cartridge.
- 2. Remove the cleaning cartridge from the drive.